

**HRTR 3B "L"**

**Diffuse reflection light scanner with background suppression**

en 02-2011/04 50111449

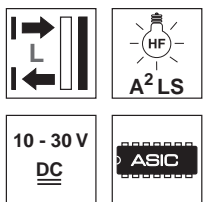

**5 ... 100mm**  
60mm with  
black-white error < 10%

- Diffuse reflection light scanner with visible red light and adjustable background suppression
- Wide, rectangular light spot guarantees the reliable detection of:
  - objects with openings, holes and grooves
  - transparent foils and bottles
  - objects with grid structures (e.g. blister packs)
  - objects with variable position
- Small and compact construction with robust plastic housing, protection class IP 67 for industrial application
- A²LS- Active Ambient Light Suppression
- Push-pull switching outputs
- Specially designed for use with fluorescent lamps with electronic HF-ballast



**Accessories:**

(available separately)

- Mounting systems (BT 3...)
- Cable with M8 or M12 connector (K-D ...)

**Dimensioned drawing**

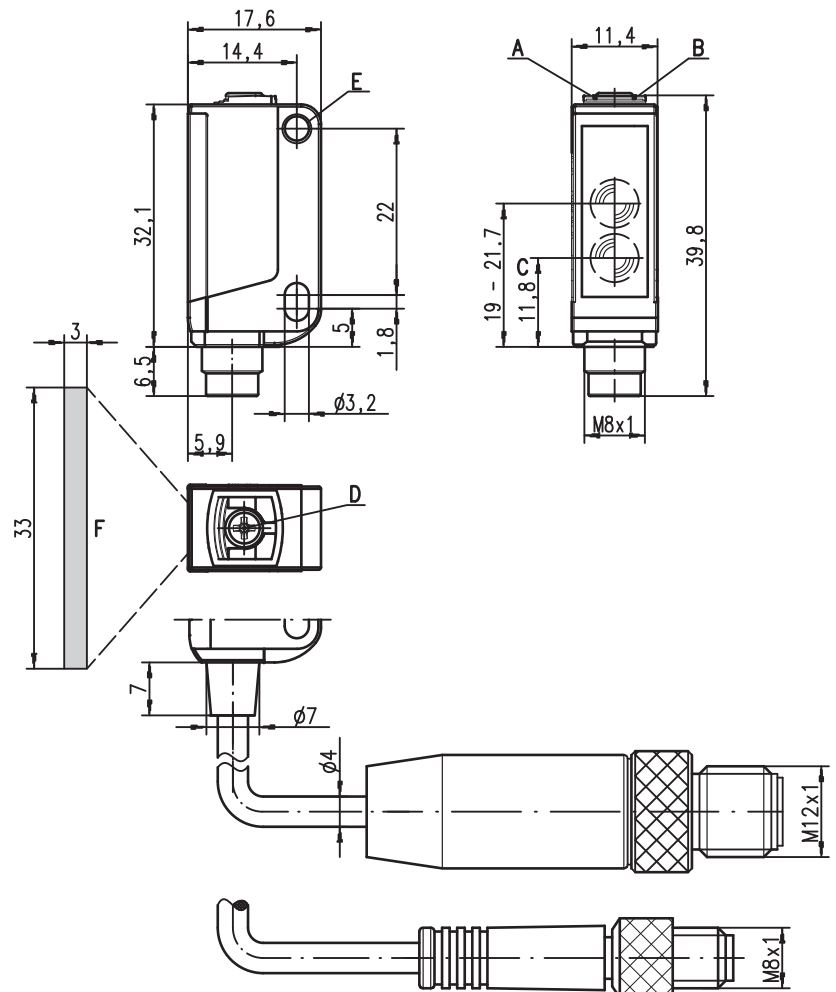

- A** Green indicator diode
- B** Yellow indicator diode
- C** Optical axis
- D** 8-turn potentiometer for scanning range adjustment
- E** Attachment sleeve
- F** Light spot 3x33mm at a scanning range of 50mm

**Electrical connection**

Plug connection, 4-pin

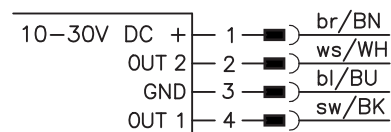

We reserve the right to make changes • DS\_HRTR3B\_44-L\_en.fm

**Specifications**

**Optical data**

|   |                                       |
|---|---------------------------------------|
| Typ. scanning range limit <sup>1)</sup> | 5 ... 100mm                           |
| Scanning range <sup>2)</sup>            | see tables                            |
| Adjustment range                        | 20 ... 100mm                          |
| Light spot                              | approx. 3 x 33mm <sup>2</sup> at 50mm |
| Light source <sup>3)</sup>              | LED (modulated light)                 |
| Wavelength                              | 620nm (visible red light)             |

**Timing**

|                       |                                  |
|-----------------------|----------------------------------|
| Switching frequency   | 150Hz                            |
| Response time         | 3.3ms                            |
| Delay before start-up | ≤ 300ms (acc. to. IEC 60947-5-2) |

**Electrical data**

|  |   |
|--|---|
| Operating voltage U <sub>B</sub> <sup>4)</sup> | 10 ... 30VDC (incl. residual ripple)          |
| Residual ripple                                | ≤ 15% of U <sub>B</sub>                       |
| Open-circuit current                           | ≤ 15mA  |
| Switching output                               | .../44 2 PNP switching outputs, complementary |
| Function characteristics                       | light/dark switching                          |
| Signal voltage high/low                        | ≥ (U <sub>B</sub> -2V)/≤ 2V                   |
| Output current                                 | max. 100mA                                    |
| Scanning range                                 | adjustable via 8-turn potentiometer           |

**Indicators**

|            |                              |
|------------|------------------------------|
| Green LED  | ready                        |
| Yellow LED | object detected - reflection |

**Mechanical data**

|                       |  |
|-----------------------|--|
| Housing <sup>5)</sup> | plastic (PC-ABS); 1 attachment sleeve, nickel-plated steel   |
| Optics cover          | plastic (PMMA)   |
| Weight                | with connector: 10g<br>with 200mm cable and connector: 20g<br>with 2m cable: 50g                               |
| Connection type       | 2m cable (cross section 4x0.20mm <sup>2</sup> ),<br>connector M8 metal,<br>0.2m cable with connector M8 or M12 |

**Environmental data**

|                                   |  |
|-----------------------------------|--|
| Ambient temp. (operation/storage) | -30°C ... +55°C/-30°C ... +70°C          |
| Protective circuit <sup>6)</sup>  | 2, 3                                     |
| VDE safety class                  | III                                      |
| Protection class                  | IP 67                                    |
| Light source                      | free group (in accordance with EN 62471) |
| Standards applied                 | IEC 60947-5-2                            |
| Certifications                    | UL 508 <sup>4)</sup>                     |

- 1) Typ. scan. range limit: max. achievable scanning range for light objects (white 90%)
- 2) Scanning range: recommended scanning range for objects with different diffuse reflection
- 3) Average life expectancy 100,000h at an ambient temperature of 25°C
- 4) Observe the safety regulations and installation instructions regarding power supply and wiring;  
for UL applications: only for use in "Class 2" circuits acc. to NEC
- 5) Patent Pending Publ. No. US 7,476,848 B2
- 6) 2=polarity reversal protection, 3=short-circuit protection for all transistor outputs

**Remarks**

Adapter plate: BT 3.2 (part no. 50103844) for alternate mounting on 25.4 mm hole spacing (Omron E3Z, Sick W100...)

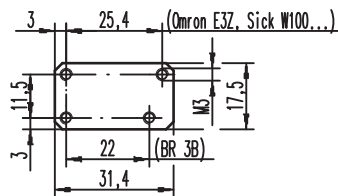

● **Approved purpose:**

This product may only be used by qualified personnel and must only be used for the approved purpose. This sensor is not a safety sensor and is not to be used for the protection of persons.

**Tables**

|   |   |    |     |
|---|---|----|-----|
| 1 | 5 | 50 | 100 |
| 2 | 5 | 45 | 90  |
| 3 | 5 | 40 | 80  |

|   |           |
|---|-----------|
| 1 | white 90% |
| 2 | grey 18%  |
| 3 | black 6%  |

□ Scanning range [mm]  
□ Typ. scanning range limit [mm]

**Diagrams**

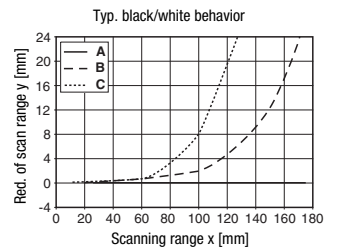

- A white 90%
- B grey 18%
- C black 6%

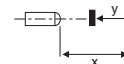

**Remarks**

Mounting system:















- ① = BT 3 (part no. 50060511)
- ②+③ = BT 3.1 <sup>1)</sup> (part no. 50105585)
- ①+②+③ = BT 3B (part no. 50105546)

1) Packaging unit: PU = 10 pcs.

# HRTR 3B "L"

# Diffuse reflection light scanner with background suppression

## Order guide

| Selection table     |  |  | Order code → |                                      |  |   |  |  |  |  |  |  |  |  |  |  |  |  |  |  |
|---------------------|--|--|--------------|--------------------------------------|--|---|--|--|--|--|--|--|--|--|--|--|--|--|--|--|
| Equipment ↓         |  |  |              | HRTR 3B/44-L-S8<br>Part No. 50111443 | HRTR 3B/44-L-200-S8<br>Part No. 50113317 |   |  |  |  |  |  |  |  |  |  |  |  |  |  |  |
| Output 1<br>(OUT 1) | push-pull switching output   |  light switching  | ○            |                                      |  |   |  |  |  |  |  |  |  |  |  |  |  |  |  |  |
|                     |  |  dark switching   | ●            |                                      |  |   |  |  |  |  |  |  |  |  |  |  |  |  |  |  |
|                     | PNP transistor output  |  light switching  | ○            | ●                                    | ●  |   |  |  |  |  |  |  |  |  |  |  |  |  |  |  |
|                     |  |  dark switching   | ●            |                                      |  |   |  |  |  |  |  |  |  |  |  |  |  |  |  |  |
|                     | NPN transistor output  |  light switching  | ○            |                                      |  |   |  |  |  |  |  |  |  |  |  |  |  |  |  |  |
|                     |  |  dark switching   | ●            |                                      |  |   |  |  |  |  |  |  |  |  |  |  |  |  |  |  |
| Output 2<br>(OUT 2) | push-pull switching output   |  light switching  | ○            |                                      |  |   |  |  |  |  |  |  |  |  |  |  |  |  |  |  |
|                     |  |  dark switching   | ●            |                                      |  |   |  |  |  |  |  |  |  |  |  |  |  |  |  |  |
|                     | PNP transistor output  |  light switching  | ○            | ●                                    | ●  |   |  |  |  |  |  |  |  |  |  |  |  |  |  |  |
|                     |  |  dark switching   | ●            |                                      |  |   |  |  |  |  |  |  |  |  |  |  |  |  |  |  |
|                     | NPN transistor output  |  light switching | ○            |                                      |  |   |  |  |  |  |  |  |  |  |  |  |  |  |  |  |
|                     |  |  dark switching | ●            |                                      |  |   |  |  |  |  |  |  |  |  |  |  |  |  |  |  |
| Connection          | cable 2,000 mm   |  | 4-wire       |                                      |  |   |  |  |  |  |  |  |  |  |  |  |  |  |  |  |
|                     | M8 connector, metal  |  | 3-pin        |                                      |  |   |  |  |  |  |  |  |  |  |  |  |  |  |  |  |
|                     | M8 connector, metal  |  | 4-pin        |                                      | ●  |   |  |  |  |  |  |  |  |  |  |  |  |  |  |  |
|                     | 200 mm cable with M8 connector                                       |  | 3-pin        |                                      |  |   |  |  |  |  |  |  |  |  |  |  |  |  |  |  |
|                     | 200 mm cable with M8 connector                                       |  | 4-pin        |                                      |  | ● |  |  |  |  |  |  |  |  |  |  |  |  |  |  |
|                     | 200 mm cable with M12 connector                                      |  | 4-pin        |                                      |  |   |  |  |  |  |  |  |  |  |  |  |  |  |  |  |
|                     | 200 mm cable with XHP connector                                      |  | 4-pin        |                                      |  |   |  |  |  |  |  |  |  |  |  |  |  |  |  |  |
|                     | pin 2: not assigned, suitable for connecting to AS-i coupling module |  |              |                                      |  |   |  |  |  |  |  |  |  |  |  |  |  |  |  |  |
| Configuration       | freely adjustable via 8-turn potentiometer                           |  |              | ●                                    | ●  |   |  |  |  |  |  |  |  |  |  |  |  |  |  |  |
|                     | preset to scanning range [mm]:                                       |  |              |                                      |  |   |  |  |  |  |  |  |  |  |  |  |  |  |  |  |

## Application notes



- For glossy surfaces (e.g. metals), the light beam should not be incident on the object surface at a right angle. A slight inclination is sufficient for preventing undesired direct reflections. This may result in a reduction in the scanning range.
- Outside of the scanning range, the sensor operates as an energetic diffuse reflection light scanner. Light objects can still be reliably detected up to the scanning range limit.
- The sensors are equipped with effective measures for the maximum avoidance of mutual interference should they be mounted opposite one another. Opposite mounting of multiple sensors of the same type should, however, absolutely be avoided.

