

PRK 55

Retro-reflective photoelectric sensors with polarization filter

en 05-2010/01 50106858-02



0 ... 5m
 1 kHz
T_I
 10 - 30 V DC
 A²LS
 stainless steel 316 L

- Polarized retro-reflective photoelectric sensor, autocollimation optics with visible red light
- 316L stainless steel housing in WASH-DOWN-Design
- Enclosed optics design prevents bacterial carry-overs
- ECOLAB and CleanProof+ tested
- Paperless device identification
- Scratch resistant and non-diffusive plastic front cover
- A²LS- Active Ambient Light Suppression
- High switching frequency for detection of fast events
- Easy adjustment via lockable teach button or teach input

Accessories:

- (available separately)
- Cable with M8 or M12 connector (K-D ...)
 - Cable for food and beverages
 - Reflectors for the foods industry
 - Reflectors for the pharmaceutical industry
 - Reflective tapes
 - Mounting devices

Dimensioned drawing

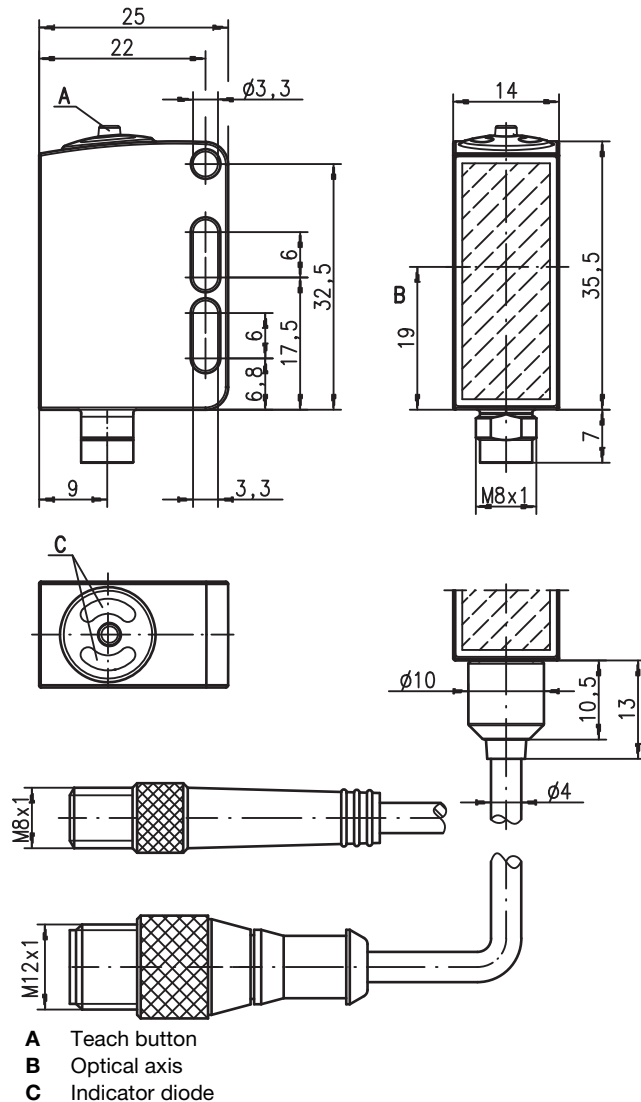

Electrical connection

Plug connection, 4-pin (with/without cable)

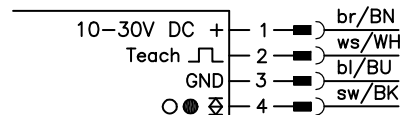

Plug connection, 3-pin

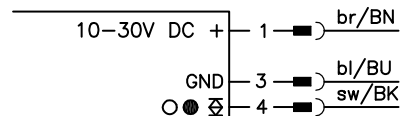

Cable, 4 wires

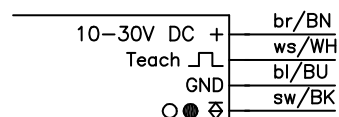

We reserve the right to make changes • DS_PRK55_6.22_en.fm

Specifications

Optical data

Typ. op. range limit (TK(S) 100x100) ¹⁾	0 ... 5m
Operating range ²⁾	see tables
Light source ³⁾	LED (modulated light)
Wavelength	620nm (visible red light, polarized)

Timing

Switching frequency	1000Hz
Response time	0.5ms
Delay before start-up	≤ 300ms

Electrical data

Operating voltage U_B ⁴⁾	10 ... 30VDC (incl. residual ripple)
Residual ripple	≤ 15% of U_B
Open-circuit current	≤ 18mA
Switching output	.../6.22 1 push-pull switching output pin 4: PNP light switching, NPN dark switching pin 2: teach input light/dark reversible
Function characteristics	≥ ($U_B - 2V$)/≤ 2V
Signal voltage high/low	max. 100mA
Output current	setting via teach-in
Operating range	

Indicators

Green LED	ready
Yellow LED	light path free
Flashing yellow LED	light path free, no performance reserve ⁵⁾

Mechanical data

Housing	AISI 316L stainless steel, DIN X2CrNiMo17132, W.No1.4404
Housing design	WASH-DOWN-Design
Housing roughness ⁶⁾	$R_a \leq 2.5$
Connector	AISI 316L stainless steel, DIN X2CrNiMo17132, W.No1.4404
Optics cover	coated plastic (PMMA), scratch resistant and non-diffusive
Operation	with M8 connector: 40g
Weight	with 200mm cable and M12 connector: 60g
	with 5000mm cable: 110g
	M8 connector, 4-pin,
	0.2m cable with M12 connector, 4-pin,
	5m cable, 4 x 0.20mm ²

Connection type

Environmental data

Ambient temp. (operation/storage) ⁷⁾	-30°C ... +70°C / -30°C ... +70°C
Protective circuit ⁸⁾	2, 3
VDE safety class ⁹⁾	III
Protection class	IP 67, IP 69K ¹⁰⁾
Environmentally tested acc. to	ECOLAB, CleanProof+
LED class	1 (acc. to EN 60825-1)
Standards applied	IEC 60947-5-2
Certifications	UL 508 ⁴⁾
Chemical resistance	tested in accordance with ECOLAB and CleanProof+ (see remarks)

Options

Teach-in input/activation input

Transmitter active/not active	≥ 8V/≤ 2V
Activation/disable delay	≤ 1ms
Input resistance	30kΩ

- 1) Typ. operating range limit: max. attainable range without performance reserve
- 2) Operating range: recommended range with performance reserve
- 3) Average life expectancy 100,000h at an ambient temperature of 25°C
- 4) For UL applications: for use in class 2 circuits according to NEC only
- 5) Display "no performance reserve" as yellow flashing LED is only available in standard teach setting
- 6) Typical value for the stainless steel housing
- 7) Operating temperatures of +70°C permissible only briefly (≤ 15min)
- 8) 2=polarity reversal protection, 3=short-circuit protection for all transistor outputs
- 9) Rating voltage 50V
- 10) Only in combination with M12 connector

Approved purpose

The photoelectric sensors are optical electronic sensors for optical, contactless detection of objects.

This product may only be used by qualified personnel and must only be used for the approved purpose. This sensor is not a safety sensor and is not to be used for the protection of persons.

Tables

Reflectors in food quality		Operating range
1	TK(S) 100x100	0 ... 4.0m
2	TK 40x60	0 ... 2.6m
3	Tape 6 50x50	0 ... 2.0m
4	TK 20x40	0 ... 1.3m
5	Tape 4 50x50	0 ... 0.7m

1	0	4	5
2	0	2.6	3.2
3	0	2.0	2.4
4	0	1.3	1.5
5	0	0.7	1.0

Pharmaceutical reflectors		Operating range
1	TK(S) 40x60.P	0 ... 1.6m
2	TK(S) 20x40.P	0 ... 1.0m
3	TK(S) 20.P	0 ... 0.7m
4	MTK(S) 14x23.P	0 ... 0.4m
5	TK 10.P	0 ... 0.3m

1	0	1.6	1.8
2	0	1.0	1.2
3	0	0.7	0.8
4	0	0.4	0.5
5	0	0.3	0.4

□ Operating range [m]
 □ Typ. operating range limit [m]

TK ... = adhesive
 TKS ... = screw type

Diagrams

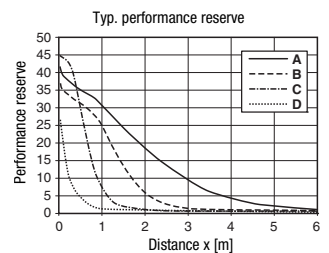
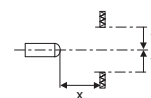
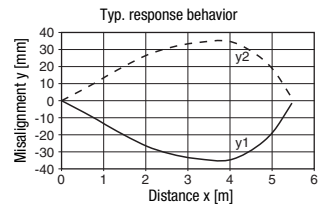

- A TK 100x100
- B TKS 40x60
- C TKS 20x40
- D Tape 4: 50x50

Remarks

A list of tested chemicals can be found in the first part of the product description.

PRK 55 **Retro-reflective photoelectric sensors with polarization filter**

Order guide

Selection table		Order code →			
Equipment ↓		PRK 55/6.22-S8 Part No. 50105792	PRK 55/6.22, 200-S12 Part No. 50105793	PRK 55/6.22-S8.3 Part No. 50107599	PRK 55/6.22, 5000 Part No. 50111967
Switching output	1 x Push-pull switching output	●	●	●	●
Switching function	light/dark switching configurable	●	●	●	●
Connection	M8 connector, metal, 4-pin	●			
	M8 connector, metal, 3-pin			●	
	cable 200mm with M12 connector, 4-pin		●		
	cable 5000mm, 4 wires				●
Configuration	teach-in via button (lockable) and teach input ¹⁾	●	●	●	●
Indicators	LED green: ready + teach sequence	●	●	●	●
	yellow LED: switching output	●	●	●	●

1) Teach input not present with 3-pin connector

Sensor adjustment (teach) via teach button



- **The sensor is factory-adjusted for maximum operating range.**
Recommendation: teach only if the desired objects are not reliably detected.
- **Prior to teaching:**
Clear the light path to the reflector!
The device setting is stored in a fail-safe way. A reconfiguration following voltage interruption or switch-off is thus not required.

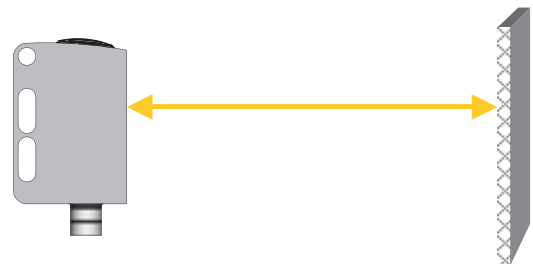

Standard teaching for average sensor sensitivity

- Press teach button until both LEDs flash **simultaneously**.
- Release teach button.
- Ready.



After the standard teaching, the sensor switches when half of the light beam is covered by the object.

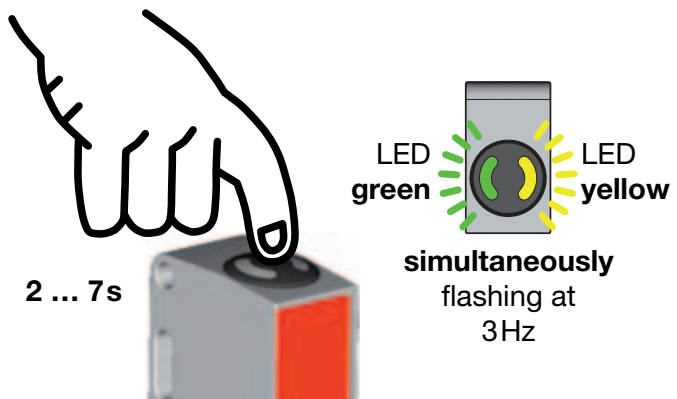

Teaching for increased sensor sensitivity

- Press teach button until both LEDs flash **alternatingly**.
- Release teach button.
- Ready.



After the teaching for increased sensor sensitivity, the sensor switches when about 18 % of the light beam are covered by the object.

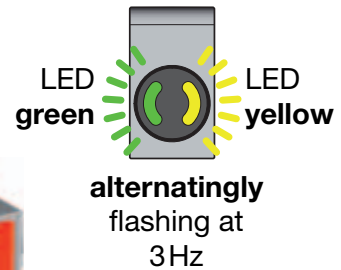
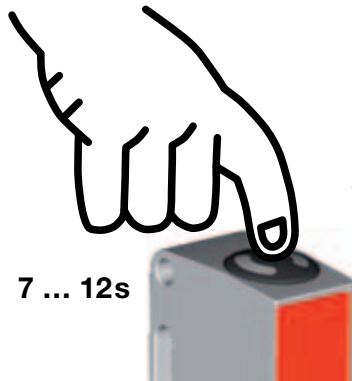

Teaching for maximum operating range (factory setting at delivery)

- Prior to teaching: **Cover the light path to the reflector!**
- Procedure as for standard teaching.

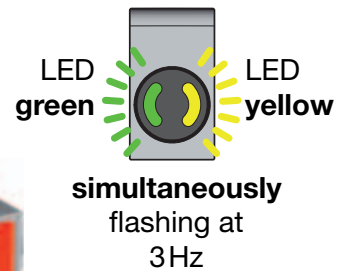
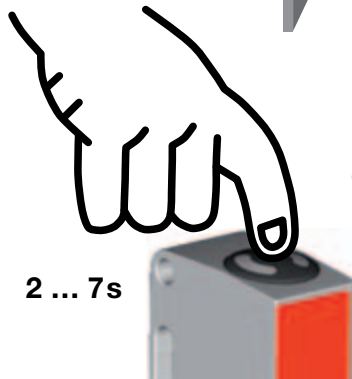
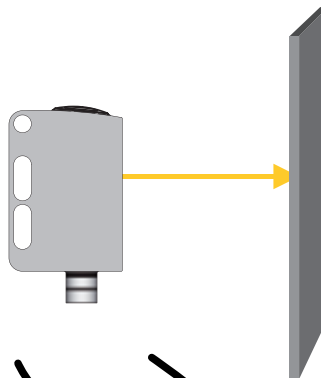

Adjusting the switching behavior of the switching output – light/dark switching

- Press teach button until the green LED flashes. The yellow LED displays the current setting of the switching output:
 ON = output switches on light
 OFF = output switches on dark
- Continue to press the teach button in order to change the switching behavior.
- Release teach button.
- Ready.

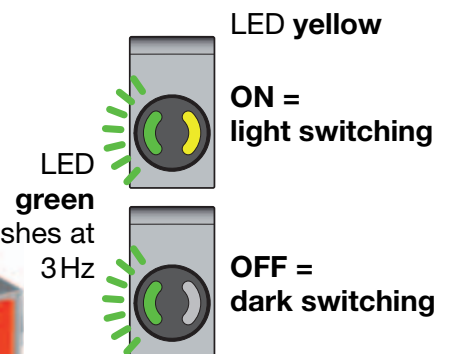
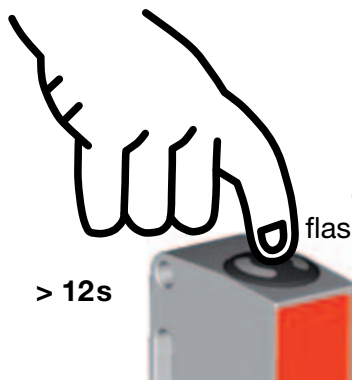

PRK 55 Retro-reflective photoelectric sensors with polarization filter

Locking the teach button via the teach input



A **static high signal** (≥ 4 ms) at the teach input locks the teach button on the device if required, such that no manual operation is possible (e.g., protection from erroneous operation or manipulation).

If the teach input is not connected or if there is a static low signal, the button is unlocked and can be operated freely.

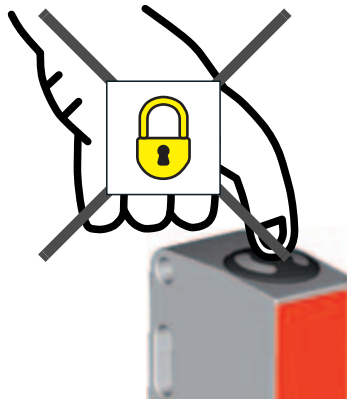

Sensor adjustment (teach) via teach input



The following description applies to PNP switching logic!

$U_{\text{Teach low}} \leq 2V$

$U_{\text{Teach high}} \geq (U_B - 2V)$

Prior to teaching: Clear the light path to the reflector!

The device setting is stored in a fail-safe way. A reconfiguration following voltage interruption or switch-off is thus not required.

Standard teaching for average sensor sensitivity

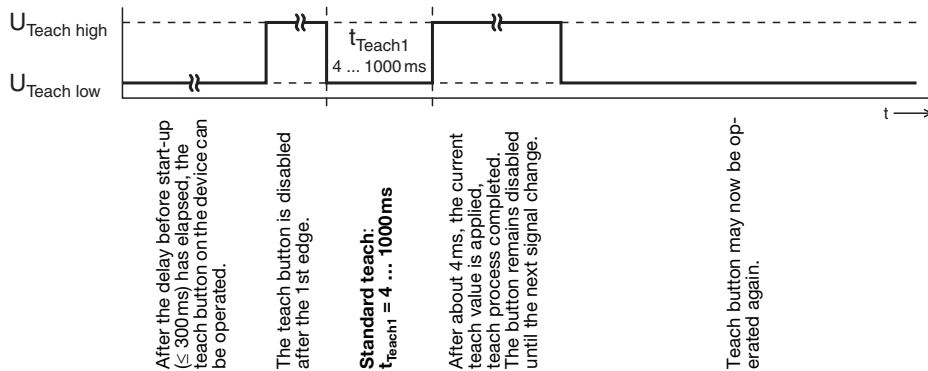

Quick standard teach

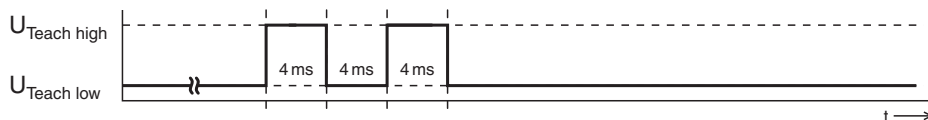

Shortest teaching duration for standard teaching: approx. 12ms



After the standard teaching, the sensor switches when half of the light beam is covered by the object.

Teaching for increased sensor sensitivity

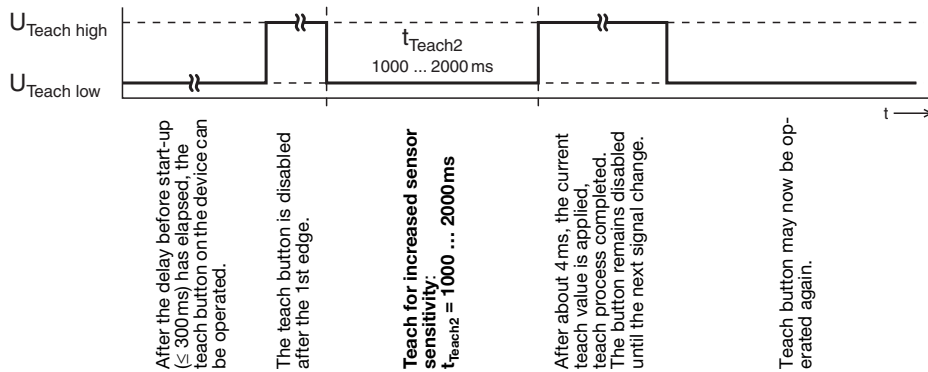

After the teaching for increased sensor sensitivity, the sensor switches when about 18% of the light beam are covered by the object.

Adjusting the switching behavior of the switching output – light/dark switching

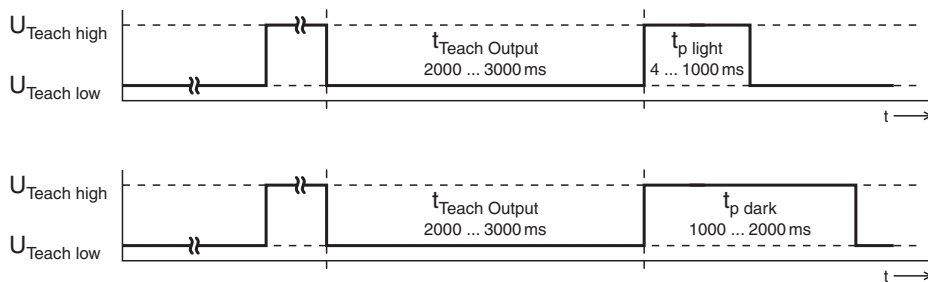

After the delay before start-up (≤ 300ms) has elapsed, the teach button on the device can be operated.

The teach button is disabled after the 1st edge.

Setting the switching behavior of the switching output:
 $t_{\text{Teach Output}} = 2000 \dots 3000 \text{ ms}$

Switching output switches on light:
 $t_{\text{p light}} = 4 \dots 1000 \text{ ms}$

Switching output switches on dark:
 $t_{\text{p dark}} = 1000 \dots 2000 \text{ ms}$

The button remains disabled until the next signal change.