

**HRT 96 Ex n**

**Laser light scanner with background suppression**

**Dimensioned drawing**

en 05-2011/01 50109140-01

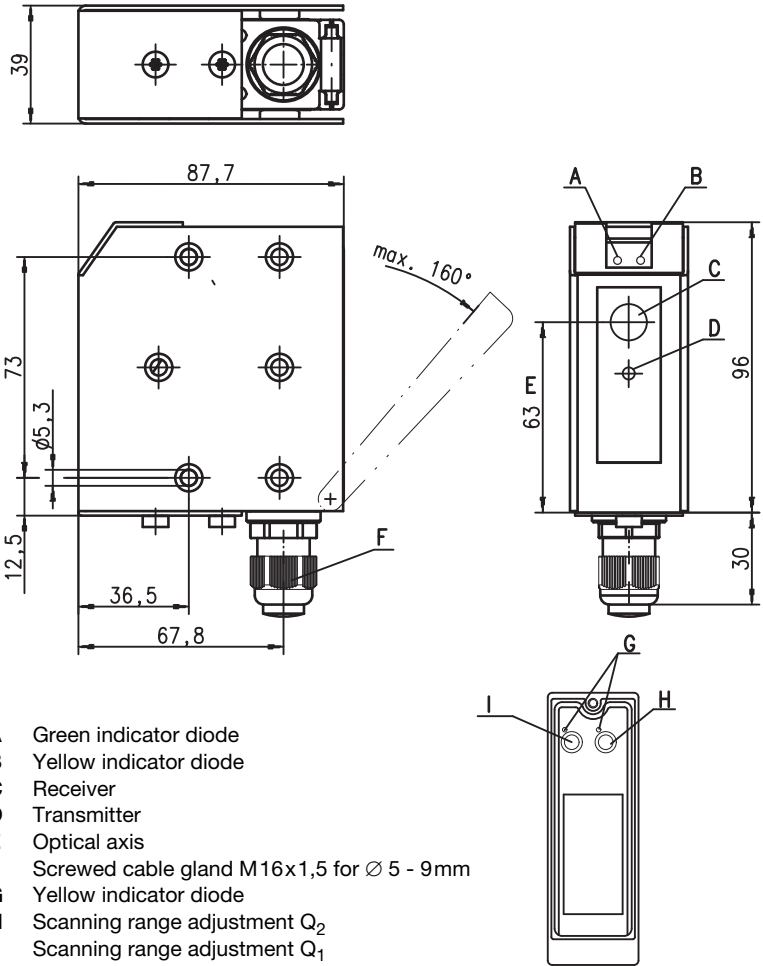

- A** Green indicator diode
- B** Yellow indicator diode
- C** Receiver
- D** Transmitter
- E** Optical axis
- F** Screwed cable gland M16x1,5 for  $\varnothing$  5 - 9mm
- G** Yellow indicator diode
- H** Scanning range adjustment Q<sub>2</sub>
- I** Scanning range adjustment Q<sub>1</sub>

**Electrical connection**

connector, 5-pin

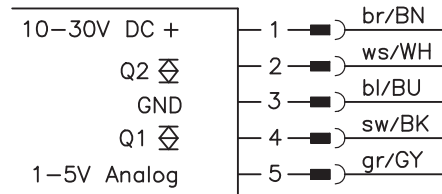

terminals

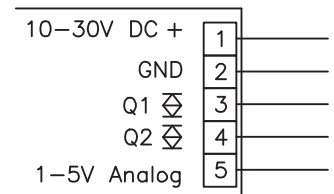

**80 ... 2500mm**



- Phase measurement makes use possible under extreme environmental conditions (brightness, light)
- Switching outputs, combined with analogue output
- Teachable switching points
- Switching behaviour independent of the direction of movement
- Clearly visible light spot for exact alignment
- Optimised for positioning tasks and reliable object detection (e.g. compartment occupancy monitoring, horizontal positioning)
- Ex II 3G Ex nA II T4
- Ex II 3D Ex tD A22 IP 67 T 70°C



**Accessories:**

(available separately)

- Mounting systems (BT 96, BT 96.1, UMS 96, BT 450.1-96)
- M12 connectors (KD ...)
- Ready-made cables (K-D ...)
- Interlocking guard K-VM12-Ex (Part No. 50109217)

We reserve the right to make changes • DS\_HRT96MP-3360-2500-21\_En\_n\_EN.frm

## Specifications

### Optical data

Typ. scanning range limit (white 90%) <sup>1)</sup>	2500mm
Scanning range <sup>2)</sup>	80 ... 2200mm
Adjustment range	300 ... 2200mm
Light source	laser (red light)
Wavelength	660nm
Laser warning notice	see remarks

### Timing

Switching frequency	40Hz
Response time	12.5ms
Delay before start-up	≤ 200ms

### Electrical data

Operating voltage $U_B$	10 ... 30VDC (incl. residual ripple)
Residual ripple	≤ 15% of $U_B$
Open-circuit current	≤ 40mA
Switching output	2 push-pull switching outputs <sup>3)</sup>
	PNP light switching, NPN dark switching
Signal voltage high/low	≥ ( $U_B - 2V$ ) / ≤ 2V
Output current	max. 100mA

### Indicators

<b>Sensor front</b>	
Green LED	ready
Yellow LED	reflection ( $Q_1$ )
<b>Sensor back</b>	see table

### Mechanical data

Housing	diecast zinc
Optics cover	glass
Weight	380g
Connection type	cablE 200mm with M12 connector, 5-pin terminals

### Environmental data

Ambient temp. (operation/storage)	0°C ... +40°C / -30°C ... +70°C
Protective circuit <sup>4)</sup>	1, 2, 3, 4
VDE safety class <sup>5)</sup>	II, all-insulated
Protection class	IP 67, IP 69K <sup>6)</sup>
Standards applied	IEC 60947-5-2

### Explosion protection

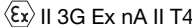
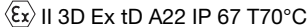
Labelling (CENELEC)	 
---------------------	--

- 1) Typ. scanning range limit: max. attainable range without performance reserve
- 2) Scanning range: recommended range with performance reserve
- 3) The push-pull switching outputs must not be connected in parallel
- 4) 1=transient protection, 2=polarity reversal protection, 3=short circuit protection for all outputs, 4=interference blanking
- 5) Rating voltage 250VAC
- 6) IP 69K test acc. to DIN 40050 part 9 simulated, high pressure cleaning conditions without the use of additives, acids and bases are not part of the test

## Order guide

Selection table		Order code →			
Equipment ↓		HRT 96M/P-3360-2500-21 Ex n Part No. 50108464	HRT 96M/P-3360-2500-21.1 Ex n Part No. 50111304		
Housing	metal	●	●		
Light source	red light/laser	●	●		
Connection	terminals, cable diameter 5 ... 9mm	●			
	200mm cable with M12 connector		●		
Outputs	3 switching points 2.5m				
	2 switching points and analogue output	●	●		
	NPN dark switching	●	●		
	PNP light switching	●	●		
	teachable switching points	●	●		

## Tables

Switching points	no reflection	object detected
LED yellow Q 1	off	on
LED yellow Q 2	off	on

### Typ. operating ranges

1	100	2000	2500
2	100	1800	1900
3	100	1500	1600

1	white 90%
2	grey 18%
3	black 6%

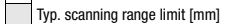
-  Scanning range [mm]
-  Typ. scanning range limit [mm]

## Remarks

- **Approved purpose:**  
This product may only be used by qualified personnel and must only be used for the approved purpose. This sensor is not a safety sensor and is not to be used for the protection of persons.
- With the set scanning range, a tolerance of the upper scanning range limit is possible depending on the reflection properties of the material surface.
- Resolution (at 90%): 50mm
- Light spot diameter  
8mm at distance of 5m  
5mm at distance of 1m
- Switching points can be set as required within the adjustment range.
- Scanning range/reflectivity:

Object/diffuse reflection	
6 ... 90%	0.1 ... 2.2m (standard)

LASER LIGHT DO NOT STARE INTO BEAM	
Maximum Output:	1.8mW
Pulse duration:	0.5µs
Wavelength:	670nm
CLASS 2 LASER PRODUCT EN60825-1:2003-10	

## Ex devices

### Operating instructions for sensors for use in potentially explosive areas of Group II, Category 3, Zones 2 ("Gas Ex") and 22 ("Dust Ex")

#### Approved purpose

The sensors produced by Leuze electronic GmbH + Co. KG for use in potentially explosive areas are sensors which function on the optical electronic principle. Without making physical contact, these sensors detect objects which are located in or which pass through the light beam.



#### Attention!

This product may only be used by qualified personnel and must only be used for the approved purpose. This sensor is not a safety sensor and is not to be used for the protection of persons.

Electrical equipment may endanger humans and (where applicable) animal health, and may threaten the safety of goods if used incorrectly and under unfavourable conditions in potentially explosive areas.

A safe operation in potentially explosive areas is only possible if the equipment is used properly and for its intended purpose.

This requires that the installation and operating instructions are adhered to and that appropriate measures are taken to ensure that this is effectively and permanently ensured.



#### Notes!

- In order to achieve a safe operation of sensors of Group II, Category 3, in potentially explosive areas, installation and protective devices appropriate to the application must ensure that operational events do not damage or overload the equipment.

#### Installation, Commissioning

In order to comply with the requirements acc. to EN 61 241-1 and EN 60 079-15, the following prerequisites must be met:

- Devices with connector (e.g. Series 46B) must be equipped with an additional safeguard or a mechanical interlocking guard K-VM12-Ex (Part No. 50109217) to avoid unintended separation of the connectors. The warning sign "Do not disconnect under voltage" that is supplied with the device must be attached to the sensor or its mounting bracket so that it is clearly visible.
- Devices with terminal compartment lid (e.g. Series 96) must only be commissioned if the terminal compartment lid of the device is properly sealed.
- Connection cables and connectors must be protected from excessive or unintended pulling or pushing strain.
- The requirements according to EN 61 241-1 regarding dust deposits and temperatures must be observed.



#### Attention!

- Due to the physical circumstances, the sensors must not be used for the protection of persons or for purposes of emergency shutdown.
- The sensors must only be installed and maintained by trained electricians.
- The applicable regulations for the installation of electrical equipment in potentially explosive areas must be observed.

#### Maintenance

No changes may be made to the sensors for potentially explosive areas.

Repairs to the sensors may only be performed by persons trained for such work or by the manufacturer. Defective devices must be replaced immediately.

Cyclical maintenance of the sensors is not necessary.

Depending on the environmental conditions, it may occasionally be necessary to clean the optical surface of the sensors. This cleaning must only be performed by appropriately trained persons. We recommend using a soft, damp cloth for this purpose. Cleaning agents that contain solvents must not be used!

#### Chemical resistance

The sensors demonstrate good resistance against many diluted acids and bases.

Exposure to organic solvents is possible only under certain circumstances and only for short periods of time.

Resistance to chemicals should be examined on a case by case basis.

**EG-Konformitätserklärung**  
*-EC Declaration of Conformity*  
*-Déclaration CE de conformité*  
*-Declaración de conformidad CE*

Name des Herstellers:

*-Name of the manufacturer:*  
*-Le constructeur:*  
*-Nombre del fabricante:*

**Leuze electronic GmbH+Co. KG**

Anschrift:

*-Address:*  
*-domicile:*  
*-Dirección:*

**In der Braike 1 D-73277 Owen/ Teck**

Erklärt unter alleiniger Verantwortung, dass das Produkt mit der Bezeichnung:

*-declares under sole responsibility that the products with the designation:*  
*-assurant sa pleine et entière responsabilité déclare que les produits avec la Référence:*  
*-declara bajo su propia responsabilidad, que los productos con el Número de pedido:*

<b>HRT 96M/P-3360-2500-21 Ex n</b>	<b>50108464</b>
<b>HRT 96M/P-1639-800-21 Ex n</b>	<b>50111087</b>
<b>HRT 96M/P-1649-800-21 Ex n</b>	<b>50111089</b>
<b>HRT 96M/P-3360-2500-21.1 Ex</b>	<b>50111304</b>

Kennzeichnung Gas:

*-Marking for gas:*  
*-Certification gaz:*  
*-Certificación gas:*

 **II 3G Ex nA II T4**

Kennzeichnung Staub:

*-Marking for dust:*  
*-Certification poussière:*  
*-Certificación polvo:*

 **II 3D Ex tD A22 IP67 T70°C**

Folgenden Richtlinien und Normen für die Gerätegruppe II, Gerätekategorie 3 entsprechen und bei bestimmungsgemäßer Verwendung und Beachtung der Betriebsanleitung die grundlegenden Sicherheits- und Gesundheitsanforderungen erfüllen.

*-conform to the following directives and standards for equipment group II, equipment category 3. They fulfil the basic health and safety requirements if used as intended and in accordance with the operating manual.*  
*-sont conformes aux directives et normes ci-dessous pour les appareils du groupe II, catégorie 3 et que sous réserve d'utilisation conforme et du respect des consignes du manuel d'utilisation ceux-ci répondent aux exigences fondamentales pour la sécurité et la santé.*  
*-corresponden a las directivas y normas para grupo de aparatos II categoría de aparatos 3 y que cumplen los requerimientos de seguridad y de salud al ser empleados debidamente teniendo en cuenta las instrucciones de uso.*

Richtlinie 94/9/EG / Richtlinie 89/336/EWG

*-Directive 94/9/EC / Directive 89/336/EEC*  
*-Directive 94/9/CE / Directive 89/336/CEE*  
*-Directiva 94/9/CE / Directiva 89/336/CEE*

**EN 60947-5-2:1998+A1:1999+A2:2004**

**EN 60825-1:1994+A1:2002+A2:2001**  
**EN 60079-15:2005**  
**EN 61241-1:2004**

Owen, den 10. Juni 2009

  
 Dr. Harald Grübel (Geschäftsführer/ General Manager/ Directeur / Gerente)

Leuze electronic GmbH + Co. KG  
 In der Braike 1  
 D-73277 Owen  
 Telefon +49 (0) 7021 573-0  
 Telefax +49 (0) 7021 573-199  
 info@leuze.de  
 www.leuze.com

Leuze electronic GmbH + Co. KG, Sitz Owen, Regenergasse Stuttgart, HRB 230712  
 Persönlich leitend: Geschäftsführer Leuze electronic, Geschäftsführung-GmbH  
 Sitz Owen, Regenergasse Stuttgart, HRB 230560  
 Geschäftsführer: Dr. Harald Grübel (Vorstand), Finken Art  
 LGB 1504 DE 1499 7521 Zulassung: 2564727  
 Es gelten ausschließlich unsere aktuellen Verkaufs- und Lieferbed.ungen.  
 Our current terms and Conditions of Sale and Delivery shall apply.



