

Part No. 501 10222



M12
2 mm
4 mm
6 mm



embedded

- Slim and very short cylindrical metal housing M12
- Chromium-plated brass housing
- Built-in short circuit protection, inductive protection and polarity reversal protection
- LED for switching state visible from 360°



Accessories:

(available separately)

- M12 connectors (KD ...)
- Ready-made cables (K-D ...)
- Mounting clamp (MC 012...)

Dimensioned drawing

ISS 212...-2E0-S12
ISS 212...-4E0-S12

ISS 212...-6E0-S12

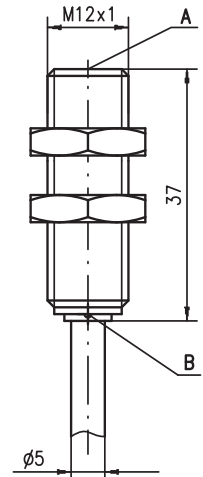
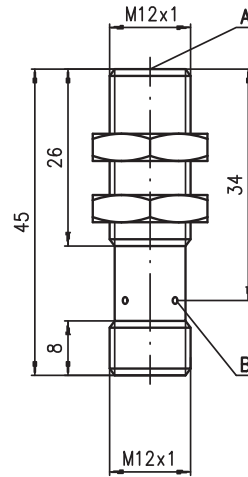
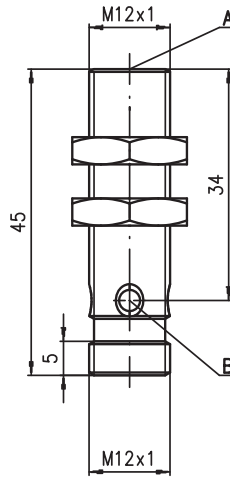

Tightening torque of the fastening nuts < 10Nm !

- A** Active surface
- B** Yellow indicator diode

Electrical connection

Cable

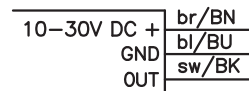

M12 connector

...NO... (normally open)

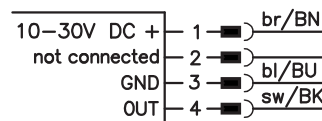

...NC... (normally closed)

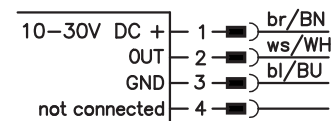

...NO...-S12 (normally open):
...NC...-S12 (normally closed):

3-pin or 4-pin M12 connection cables can be used.
only 4-pin M12 connection cables can be used.

We reserve the right to make changes • 212_03gb.fm

Specifications

General specifications	ISS 212...-2E0...	ISS 212...-4E0...	ISS 212...-6E0...
Type of installation	embedded installation		
Typ. operating range limit S_n	2.0mm	4.0mm	6.0mm
Operating range S_a	0 ... 1.6mm	0 ... 3.2mm	0 ... 4.8mm
Electrical data			
Operating voltage U_B ¹⁾	10 ... 30VDC		
Residual ripple σ	$\leq 20\%$ of U_B		
Output current I_L	$\leq 200\text{mA}$		
Open-circuit current I_0	$\leq 10\text{mA}$		
Residual current I_r	$\leq 100\mu\text{A}$		
Switching output/function	.../4NO...	PNP transistor, make-contact (NO)	
	.../4NC...	PNP transistor, break-contact (NC)	
	.../2NO...	NPN transistor, make-contact (NO)	
	.../2NC...	NPN transistor, break-contact (NC)	
Voltage drop U_d	$\leq 2\text{V}$		
Hysteresis H of S_r	$\leq 10\%$	$\leq 15\%$	$\leq 10\%$
Temperature drift of S_r	$\leq 10\%$ ²⁾		
Repeatability	$\leq 5\%$ ³⁾		
Timing			
Switching frequency f	3kHz	2kHz	800Hz
Delay before start-up	$\leq 10\text{ms}$	$\leq 300\text{ms}$	$\leq 50\text{ms}$
Indicators			
Yellow LED (visible from 360°)	switching state		
Mechanical data			
Housing	chromium-plated brass		
Standard surface plate	12 x 12mm ² , Fe360	12 x 12mm ² , Fe360	18 x 18mm ² , Fe360
Active surface	PBTP		
Weight (M12 plug/cable)	approx. 25g/ approx. 95g		
Connection type	M12 connector 4-pin or cable: 2m, PVC, 3 x 0.34mm ² , \varnothing 5.0mm		
Environmental data			
Ambient temperature	-25°C ... +70°C		
Protection class	IP 67		
Protective circuit ⁴⁾	1, 2, 3		
Standards applied	IEC/EN 60947-5-2		
Electromagnetic compatibility	IEC 60255-5	1kV	
	IEC 61000-4-2	Level 3 air 8kV (ESD)	
	IEC 61000-4-3	Level 3 10V/m (RFI)	
	IEC 61000-4-4	Level 3 2kV (Burst)	

- 1) Observe the safety regulations and installation instructions regarding power supply and wiring; for UL applications: only for use in "Class 2" circuits acc. to NEC
- 2) Over the entire operating temperature range
- 3) For $U_B = 20 \dots 30\text{VDC}$, ambient temperature $T_a = 23^\circ\text{C} \pm 5^\circ\text{C}$
- 4) 1=polarity reversal protection, 2=short circuit protection, 3=inductive protection for all outputs

Order guide

The sensors listed here are preferred types; current information at www.leuze.com.

S_n	Designation	Part No.
$S_n = 4\text{mm}$	ISS 212 MM/4NO-4E0	501 09684
	ISS 212 MM/4NO-4E0-S12	501 09685
	ISS 212 MM/4NC-4E0-S12	501 09676
	ISS 212 MM/2NO-4E0-S12	501 09687
$S_n = 6\text{mm}$	ISS 212 MM/4NO-6E0-S12	501 09679
	ISS 212 MM/2NO-6E0-S12	501 09688

Tables

Reduction factors:

for $S_n = 2.0\text{mm}$		for $S_n = 4.0\text{mm}$	
Steel Fe360	1	Steel Fe360	1
Copper	0.20	Copper	0.40
Aluminum	0.30	Aluminum	0.44
Brass	0.40	Brass	0.54
Stainless steel	0.85	Stainless steel	0.80

for $S_n = 6.0\text{mm}$

Steel Fe360	1
Copper	0.25
Aluminum	0.30
Brass	0.40
Stainless steel	0.70

Mounting

Embedded installation:

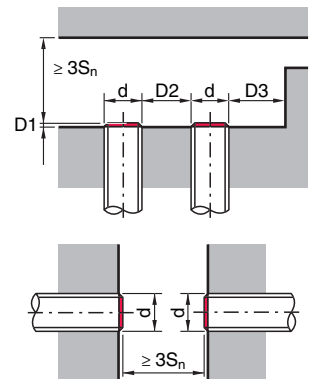

Ferromagnetic and non-ferromagnetic materials			
S_n [mm]	D1 [mm]	D2 [mm]	D3 [mm]
2.0	0	6.0	2.0
4.0	0	12.0	4.0
6.0	2.0	18.0	6.0

Diagrams

Models with $S_n = 2.0\text{mm}$

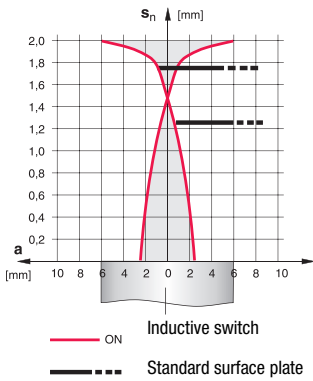

Models with $S_n = 4.0\text{mm}$

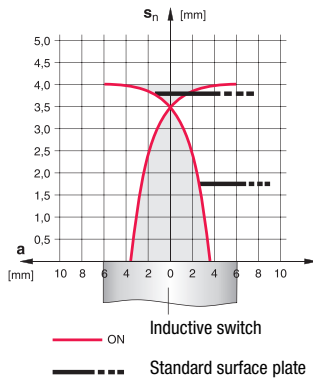

Models with $S_n = 6.0\text{mm}$

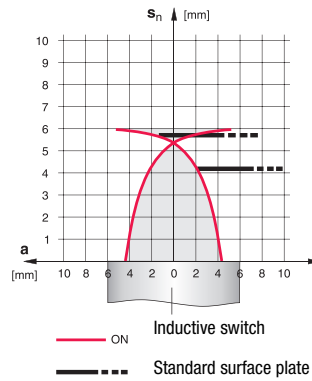

Type key

I S S 2 1 2 M M / 4 N O - 4 E 0 - S 1 2

Operating principle / construction

ISS Inductive switch / short construction

Series

212 series with M12 x 1 external thread

Housing / thread

MM metal housing (active surface: plastic) / metric thread

Output function

- 4NO PNP transistor, make-contact (NO)
- 4NC PNP transistor, break-contact (NC)
- 2NO NPN transistor, make-contact (NO)
- 2NC NPN transistor, break-contact (NC)

Measurement range / type of installation

- 2E0 typ. scan range limit 2.0mm / embedded installation
- 4E0 typ. scan range limit 4.0mm / embedded installation
- 6E0 typ. scan range limit 6.0mm / embedded installation

Electrical connection

- N/A cable, PVC, standard length 2000mm
- S12 M12 connector, 4-pin, axial
- 200-S12 cable, PVC, length 200mm with M12 connector, 4-pin, axial

Remarks

- **Approved purpose:**
Inductive switches are electronic sensors used for the inductive, contactless detection of objects.

