

HRTR 46B

Diffuse reflection light scanner with background suppression

en 01-2011/05 50114845



Dimensioned drawing

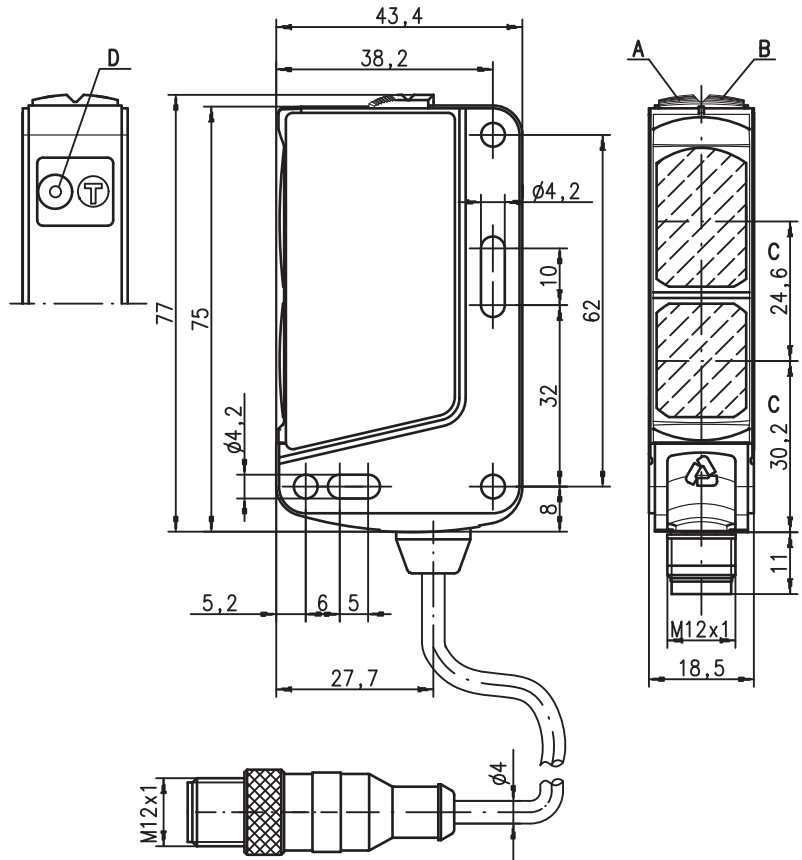

- A Green indicator diode
- B Yellow indicator diode
- C Optical axis
- D Teach button

20 ... 1,800mm
1000mm with
typical black-white error < 10%

10 - 30 V DC, IO-Link, and other icons.

- Reproducible scanning range adjustment via teach-in in different teach variants
- Robust behavior through innovative ASIC technology
- Variants with 2 individual switching points
- Scanning range adjustment from control via IO-Link interface
- Comprehensive diagnostic options via IO-Link interface
- Remote teach via cable
- Button locking
- Fast alignment through *brightVision*[®]
- A²LS - Active Ambient Light Suppression

Electrical connection

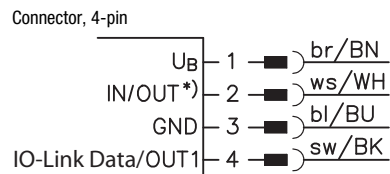

Selection pin 2

*)	OUT
	OUT 2
	Teach

Additional functions configurable via IO-Link

CE, ISO 9001, UL LISTED, ECOLAB, IEC 60947, IP 69K IP 67, and other certification icons.

Accessories:

- (available separately)
- Mounting systems (BT 46, BT 46.1, BT 46.1.5, BT 46.2)
 - M12 connectors (KD ...)
 - Ready-made cables (K-D ...)
 - IO-Link Master SET MD12-US2-IOL1+Zub

We reserve the right to make changes • DS_HRTR_46B_Teach_en.fm

Specifications

Optical data

Typ. scanning range limit (white 90%) ¹⁾	20 ... 1,800mm
Scanning range ²⁾	see tables
Adjustment range	120 ... 1,800mm
Light source	LED (modulated light)
Wavelength	620nm (visible red light)

Red light

Sensor operating modes

IO-Link	COM2 (38.1kBAud), Frame 2.5, Vers. 1.0, min. cycle time 7.5ms is supported
SIO	

Timing

Switching frequency	200Hz ³⁾
Response time	2.5ms ³⁾
Delay before start-up	≤ 100ms

Electrical data

Operating voltage U_B ⁴⁾	10 ... 30VDC, for COM2: 18 ... 30V (incl. residual ripple)
Residual ripple	≤ 15% of U_B
Open-circuit current	≤ 25 mA at 24V ⁵⁾
Switching output	.../66. ... push-pull switching outputs ⁶⁾
	pin 2: PNP dark switching, NPN light switching
	pin 4: PNP light switching, NPN dark switching
	.../6. ... push-pull switching output ⁶⁾
	pin 4: PNP light switching, NPN dark switching
	pin 2: PNP switching output, light switching
	pin 4: IO-Link data, in SIO push-pull mode ⁶⁾
	.../L4. ... pin 4: IO-Link data, in SIO push-pull mode ⁶⁾
	.../L. ... $\geq (U_B - 2V) / \leq 2V$
Signal voltage high/low	max. 100mA
Output current	

Indicators

Green LED in continuous light	ready
Yellow LED in continuous light	reflection
Yellow LED, flashing	reflection, no performance reserve
Green and yellow LED flashing at 9Hz	teaching error

Mechanical data

Housing	plastic
Optics cover	plastic
Weight	50g (with connector) / 65g (with cable and conn.)
Connection type	M12 connector, or cable with M12 connector, cable length: 200mm

Environmental data

Ambient temp. (operation/storage)	-40°C ... +60°C / -40°C ... +70°C
Protective circuit ⁷⁾	2, 3
VDE safety class ⁸⁾	II, all-insulated
Protection class	IP 67, IP 69K
LED class	1 (acc. to EN 60825-1)
Standards applied	IEC 60947-5-2

Options

Teach-in, line teach, teach button lock,
Warning message autocontrol to signal low performance reserve via IO-Link counting principle,
Activation input **activ** via IO-Link,
Time functions configurable via IO-Link,

- 1) Typ. scan. range limit: max. achievable scanning range for light objects (white 90%)
- 2) Scanning range: recommended scanning range for objects with different diffuse reflection
- 3) Switching frequency 100Hz, response time 5ms for sensors with two individual HRTR 46B ... switching outputs .23 ... , 65Hz / 7.5ms in IO-Link communication mode
- 4) For UL applications: for use in class 2 circuits only
- 5) ≤ 45mA at 10V
- 6) The push-pull switching outputs must not be connected in parallel
- 7) 2=polarity reversal protection, 3=short-circuit protection for all outputs
- 8) Rating voltage 50V

Order guide

The sensors listed here are preferred types; current information at www.leuze.com.

With M12 connector

	Designation	Part No.
Pin 4 PNP switching output, pin 2 teach input	HRTR 46B/6.22-S12	50114032
2 individually teachable switching outputs, IO-Link interface	HRTR 46B/L4.23-S12	50114037

Cable with M12 connector

Pin 4 PNP switching output, pin 2 teach input	HRTR 46B/6.22,200-S12	50114034
---	-----------------------	----------

Tables

1	20	1,800
2	20	1,200
3	20	1000

1	white 90%
2	grey 18%
3	black 6%

Scanning range [mm]

Diagrams

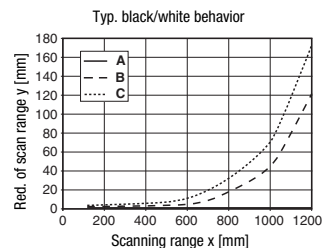
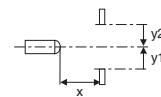
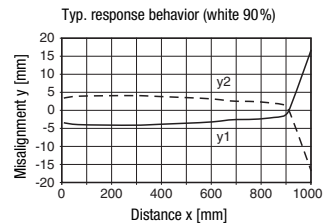

- A white 90%
- B grey 18%
- C black 6%

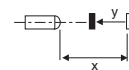

Remarks

- **Approved purpose:**
This product may only be used by qualified personnel and must only be used for the approved purpose. This sensor is not a safety sensor and is not to be used for the protection of persons.
- With the set scanning range, a tolerance of the upper scanning range limit is possible depending on the reflection properties of the material surface.

HRTR 46B

Diffuse reflection light scanner with background suppression

Type key

HRTR 46B / 6 . 22 - S12

Operating principle

HRTR Scanner with background suppression with light visible red light

Series

46B 46B Series

Switching output

/66 Complementary push-pull switching outputs
/44 Complementary PNP switching outputs
/4 Pin 4 PNP switching output, pin 2 no contact or teach input
/6 Pin 4 push-pull switching output, pin 2 no contact or teach input
/L4 Pin 4 IO-Link data or in SIO push-pull switching output, pin 2 PNP output
/L Pin 4 IO-Link data or in SIO push-pull switching output, pin 2 no contact or teach input

Function characteristics

N/A Pin 4 light switching; with push-pull, PNP light switching
D Inverted switching logic

Product versions

.22 Pin 2 teach input, standard teach
.23 Two individually teachable switching points

Product modifications

-xxx Scanning range in mm, only for preset sensors (only on request)
-xxxXF Permanent setting (only on request)

Electrical connection

N/A Cable, standard length 2000 mm
,200-S12 Cable, length 200 mm with M12 connector
-S12 M12 connector

IO-Link process data

Output data device

Data bit								Assignment	Meaning
7	6	5	4	3	2	1	0		
								Switching output Q1	0 = inactive, 1 = active
								Switching output Q2	0 = inactive, 1 = active
								Warning output autoControl	0 = no warning, 1 = warning
								Sensor operation ¹⁾	0 = off, 1 = on
								Not assigned	free
								Not assigned	free
								Not assigned	free
								Not assigned	free

1) Sensor operation off when detection is not possible (e.g during the teach event)

Input data device

Data bit								Assignment	Meaning
7	6	5	4	3	2	1	0		
								Deactivation	0 = transmitter active, 1 = transmitter inactive
								Not assigned	free
								Not assigned	free
								Not assigned	free
								Not assigned	free
								Not assigned	free
								Not assigned	free

IO-Link service data

The sensors which feature an IO-Link interface can be configured and diagnosed via the service data.

Parameters

Enabling/locking teach button:

Manipulation protection can be activated with this parameter.

Functions on operating levels 1 and 2:

The teach process for two operating levels is determined here. A teach on background and teach on object are available on each. On operating level 1, scanning range 1 is always taught, on operating level 2, scanning range 2 is always taught. The teach in can be triggered via the "**Teach scanning range**" system command or via the teach button.

R1 and R2 reserves:

Configuration of the reserves in % of the scanning range which is used for the teach-in. The reserve is the value by which the scanning range is increased (during teach on object) or decreased (during teach on background) in relation to the position of the teach object. Reserves of 0 ... 20% are possible. A new reserve value does not take effect for a switching point until after a teach event is performed.

Scanning ranges 1 and 2:

The scanning ranges of the sensor can be directly set in millimeters here. The maximum absolute error of the configured scanning range on a bright, diffuse object is 10% in the distance range of 120 ... 1000mm. Since the change of a scanning range can happen very often in a process, e.g. with format conversions, the scanning range set via this parameter is only kept in the volatile memory of the sensor for reasons of life expectancy. The values can be saved in the permanent memory with the "**Permanently save scanning range**" system command.

Functions of pins 2 and 4:

The following functions can be configured for SIO operation for the inputs/outputs on pins 2 and 4:

- Switching outputs
- Warning output
- Activation input
- Teach input

Time module:

All normal time functions can be configured in a range of 10ms ... 25s via the time module. The activated time function is effective for both switching outputs.

Setting factory settings:

The factory settings of the sensor can be restored via the "**Set factory settings**" system command.

Diagnostics (observation)

Reading out of the signal quality:

Excellent signal quality: The object is detected reliably

Good signal quality: The object is detected reliably if no heavy soiling of the lenses or a large variation of the objects is to be expected in the application.

Low reception signal: The object is not detected reliably in this position because either the signal from the object is very low or the object is located near the switching point.

Reception signal is not sufficient: Either no object is in the scanning area or the signal from the object is too low for detection.

Reading out of the object distance:

The distance to the object, which is currently located in the light beam, can be measured via the "**Distance measurement**" system command. The sensor function is not in operation during the measurement process.

Detailed information about the IO-Link service data and the IODD can be found at www.leuze.com.

HRTR 46B

Diffuse reflection light scanner with background suppression

Teach process

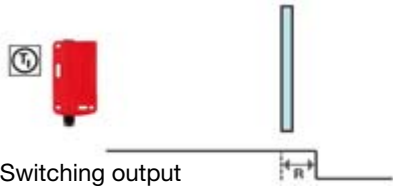
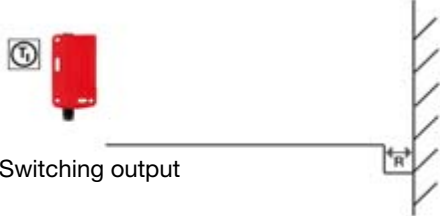
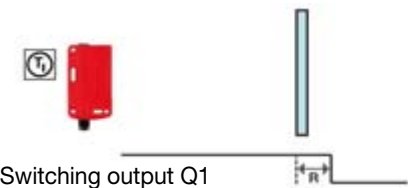
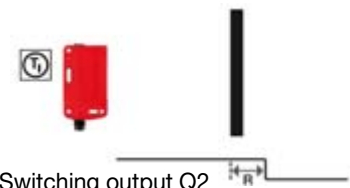
Teach	Operating level 1	Operating level 2
<p>Standard teach (e.g. HRTR 46B... .22...)</p>	<p>Teach on object:</p> <p>In this teach version, the switching distance is set so that the object that is in the beam path during the teach is detected with a tight reserve. The additional distance by which the scanning range is increased in relation to the distance to the teach object is designated as reserve R. All objects up to a bit above the distance of the object used in the teach are thus detected.</p>  <p>Switching output</p>	<p>Teach on background:</p> <p>This teach is only suitable for applications with a fixed background. The teach is carried out without an object. The scanning range is placed in front of the teach object with reserve R. The scanning range is set by the teach so that detection stops just short of the background.</p>  <p>Switching output</p>
<p>Teach for two individual switching points (e.g. HRTR 46B... .23...)</p>	<p>Teach on object for Q1 (pin 4):</p> <p>In this teach version, the switching distance for switching output Q1 is set so that the object that is in the beam path during the teach is detected with a tight reserve. The additional distance by which the scanning range is increased in relation to the distance to the teach object is designated as reserve R. All objects up to a bit farther than the distance of the object used in the teach are thus signaled on switching output Q1.</p>  <p>Switching output Q1</p>	<p>Teach on object for Q2 (pin 2):</p> <p>In this teach version, the switching distance for switching output Q2 is set so that the object that is in the beam path during the teach is detected with a tight reserve. The additional distance by which the scanning range is increased in relation to the distance to the teach object is designated as reserve R. All objects up to a bit farther than the distance of the object used in the teach are thus signaled on switching output Q2.</p>  <p>Switching output Q2</p>



The scanners have a reserve **R** of approx. 3% as a factory setting.

Operation via teach button

Teach in operating level 1

- Press teach button until both LEDs flash simultaneously.
- Release teach button.
- Ready.



2 ... 7s



simultaneously
flashing at
3Hz

Teach in operating level 2

- Press teach button until both LEDs flash alternately.
- Release teach button.
- Ready.



7 ... 12s



alternately
flashing at
3Hz

Adjusting the switching behavior of the switching output – light/dark switching

This function permits inversion of the sensors' switching logic.

- Press the teach button until only the green LED flashes. The yellow LED then shows the inverted switching logic:

ON = switching outputs light switching (in the case of complementary sensors, Q1 (pin 4) light switching, Q2 (pin 2) dark switching), this means output active when object is detected.

OFF = switching outputs dark switching (in the case of complementary sensors, Q1 (pin 4) dark switching, Q2 (pin 2) light switching), this means output inactive when object is detected.



> 12s

LED yellow

ON = light switching

OFF = dark switching



LED green
flashes with
3Hz

- Release teach button.
- Ready.

HRTR 46B

Diffuse reflection light scanner with background suppression

EasyTune - fine tuning of the scanning range in 2% increments

Only available in devices with a switching point (HRTR 46B/6.22...)!

- Following power-on and completed teach event:
Green LED illuminates continuously: ready
Yellow LED: switching output active/not active
- Increasing scanning range by +2% (increment):
Each time the button is pressed between 200ms and 2s, the scanning range is increased; for example:
Scanning range 500mm -> approx. 510mm after EasyTune.

The press of the button is confirmed by **one brief green flash of the green LED** - the new scanning range is now valid.

Long press of the button = large force expenditure = scanning range +2%



200ms ... 2s

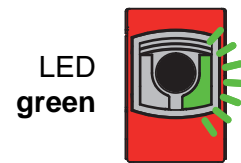

LED green

Flashes briefly 1 time

- Decreasing scanning range by -2% (decrement):
Each time the button is pressed between 2ms and 200ms, the scanning range is decreased; for example:
Scanning range 500mm -> approx. 490mm after EasyTune.

The press of the button is confirmed by **one brief green flash of the green LED** - the new scanning range is now valid.

Short press of the button = small force expenditure = scanning range -2%



2ms ... 200ms

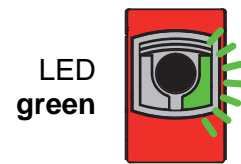

LED green

Flashes briefly 1 time



If the upper or lower end of the adjustment range is reached, the green and yellow LED flash synchronously for 1 second with a considerably higher frequency of approx. 9Hz.

The yellow LED always shows the state of the switching output!

Setting factory settings:

It's possible to restore the factory settings of the sensor via the teach button.

- Continue to press the teach button during power-on. The green and the yellow LEDs flash synchronously.
- Continue to press the teach button until green and yellow LEDs flash synchronously.
- Release teach button.

The factory settings of the sensor have been restored.



7 ... 10s



LED yellow

LED green

simultaneously
flashing for 7s
with 3Hz



LED yellow

LED green

alternately
flashing at
3Hz

Sensor adjustment (teach) via teach input (pin 2)



The following description applies to PNP switching logic!

Signal level LOW $\leq 2V$

Signal level HIGH $\geq (U_B - 2V)$

With the NPN models, the signal levels are inverted!

Line teach operating level 1

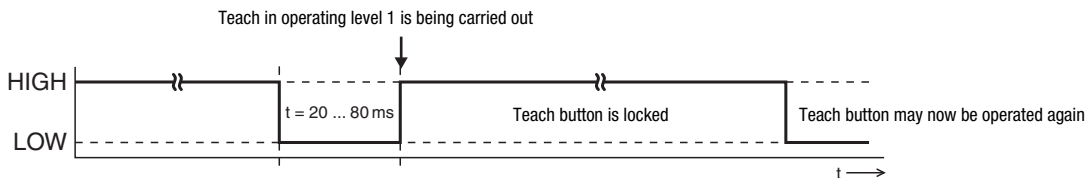

Line teach operating level 2

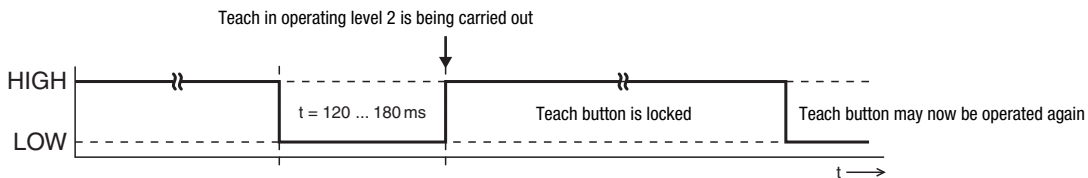

Light switching logic

Switching outputs light switching, this means outputs active when object is detected. In the case of complementary switching outputs, Q1 (pin 4) light switching, Q2 (pin 2) dark switching.

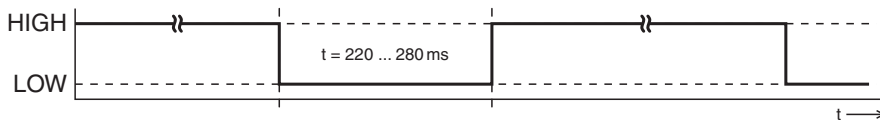

Dark switching logic

Switching outputs dark switching, this means outputs inactive when object is detected. In the case of complementary switching outputs, Q1 (pin 4) dark switching, Q2 (pin 2) light switching.

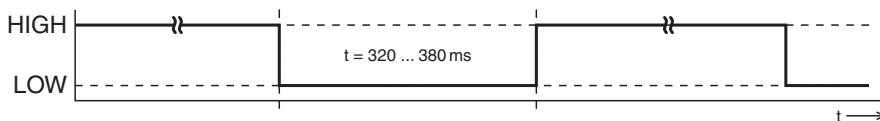

Locking the teach button via teach input (Pin 2)



A **static HIGH signal** ($\geq 20ms$) at the teach input locks the teach button on the sensor, if required, so that no manual operation is possible (e.g., protection from erroneous operation or manipulation).

If the teach input is not connected or if there is a static low signal, the button is unlocked and can be operated freely.

