



RT 96

Energetic diffuse reflection light scanners



Dimensioned drawing

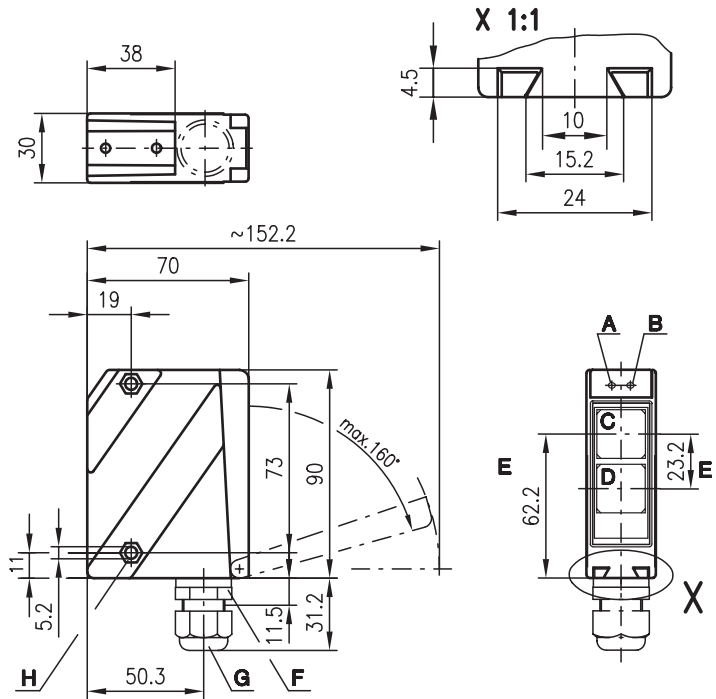

30 ... 700 mm
20 ... 1200 mm

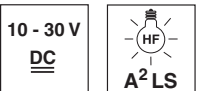

- Robust metal housing with glass cover or plastic housing, protection class IP 67/ IP 69K for industrial application
- Sensitivity adjustment and delay before start-up for optimal adaptation to the application
- Minimal short range
- Connection via M12 connector or terminal compartment
- Multiple options with warning output, activation input, switching delays and optics heating for use at low temperatures

- A Indicator diode green
- B Indicator diode yellow
- C Receiver
- D Transmitter
- E Optical axis
- F Device plug M12
- G Screwed cable gland M16x1.5 for Ø 5 ... 10mm
- H Countersinking for SK nut M5, 4.2 deep
- I Connection terminals
- K Cable entry
- L Sensitivity adjustment

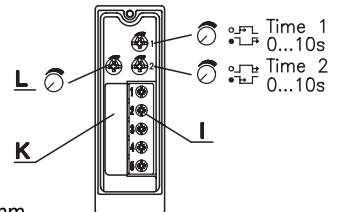

Electrical connection

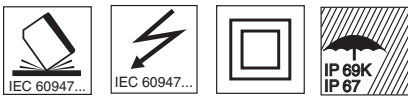
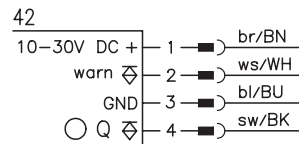

Accessories:

(available separately)

- Mounting systems (BT 96, BT 96.1, UMS 96, BT 450.1-96)
- M12 connectors (KD ...)
- Ready-made cables (K-D ...)

We reserve the right to make changes • 96_c01e.fm

Specifications

Optical data

Typ. scanning range limit (white 90%) ¹⁾
 Scanning range ²⁾
 Adjustment range
 Light source
 Wavelength

Infrared light

20 ... 1200mm
 20 ... 800mm
 0 ... 100%
 LED (modulated light)
 880nm

Red light

30 ... 700mm
 30 ... 500mm
 0 ... 100%
 LED (modulated light)
 660nm

Timing

Switching frequency 1000Hz
 Response time 0.5ms
 Delay before start-up ≤ 200ms

Electrical data

Operating voltage U_B 10 ... 30VDC (incl. residual ripple)
 Residual ripple ≤ 15% of U_B
 Bias current ≤ 40mA, ≤ 75mA with optics heating
 Switching output PNP transistor
 Function characteristics light switching
 Signal voltage high/low ≥ ($U_B - 2V$) / ≤ 2V
 Output current max. 100mA
 Sensitivity adjustable

Indicators

LED green ready
 LED yellow reflection
 LED yellow flashing reflection, no performance reserve

Mechanical data

Housing diecast zinc
 Optics cover glass
 Weight 380g
 Connection type terminals or M12 connector

Environmental data

Ambient temp. (operation/storage) -20°C ... +60°C / -40°C ... +70°C
 Protective circuit ³⁾ 1, 2, 3, 4
 VDE safety class ⁴⁾ II, all-insulated
 Protection class IP 67, IP 69K ⁵⁾
 LED class 1 (acc. to EN 60825-1)
 Standards applied IEC 60947-5-2

Options

Warning output autoControl warn PNP transistor, 100mA, counting principle
Optics heating for temperature changes, prevents fogging
Low temperature to -35°C
Switching delay (slow oper./release) 0 ... 10s (separately adjustable)

- 1) Typ. scanning range limit: max. attainable range without performance reserve
- 2) Scanning range: recommended range with performance reserve
- 3) 1=transient protection, 2=polarity reversal protection, 3=short circuit protection for all outputs, 4=interference blanking
- 4) Rating voltage 250VAC
- 5) IP 69K test acc. to DIN 40050 part 9 simulated, high pressure cleaning conditions without the use of additives, acids and bases are not part of the test

Order guide

Selection table		Order code →					
Equipment ↓		RT 96M/P-1374-500-42 Part No. 500 41596	RT 96M/P-1474-800-42 Part No. 500 41597				
Housing	metal	●	●				
	plastic						
Light source	red light (500mm)	●					
	infrared light (800mm)		●				
Connection	terminals						
	M12 connector	●	●				
Features	optics heating/low temp.						
	switching delay		●				
	warning output	●	●				
	short range (20mm)	●	●				
	NPN switching output						

Tables

Red light

1	30	500	700
2	65	320	430
3	90	200	370

Infrared light

1	20	800	1200
2	60	420	950
3	80	290	570

1	white 90%
2	grey 18%
3	black 6%

- Scanning range [mm]
- Typ. scanning range limit [mm]

Diagrams

Red light

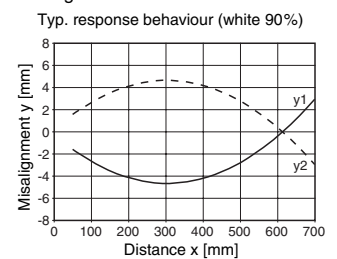

Infrared light

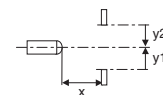
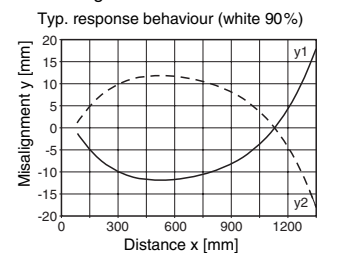

Remarks

- The upper and lower scanning range limit varies depending on the reflection properties of the material surface.
- **Short range** objects are detected down to a minimum distance of 20mm.