



RTR 8

Energetic diffuse reflection light scanner



Dimensioned drawing

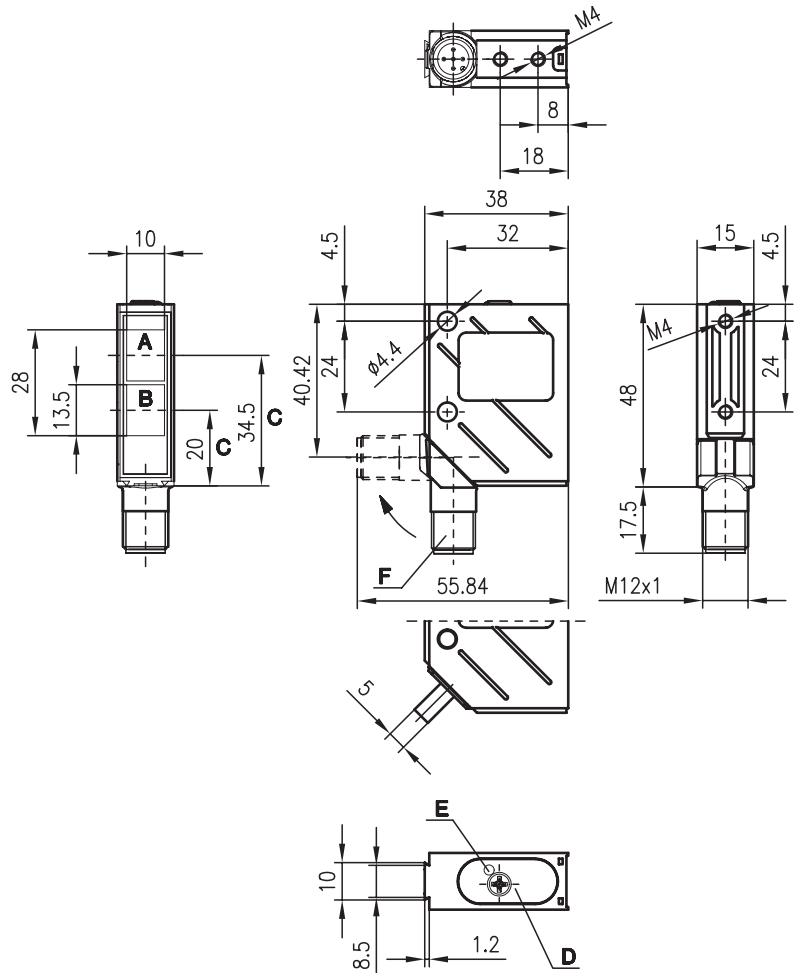

- A Receiver
- B Transmitter
- C Optical axis
- D Operational control
- E LED yellow
- F 90° turning connector



5 ... 800mm

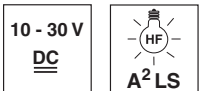

- A²LS - active suppression of extraneous light
- Push-pull switching outputs
- M12 turning connector or cable connection
- Visible red light

Electrical connection

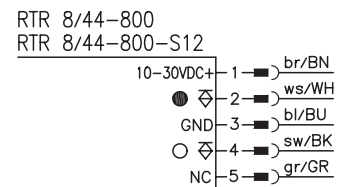
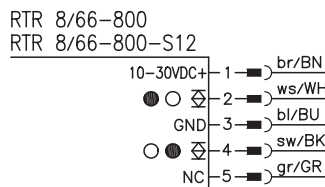

Accessories:

(available separately • see page 74)

- M12 connectors (KD ...)
- Ready-made cables (K-D ...)
- Mounting systems
- Control guard

We reserve the right to make changes • 8_c01e.fm

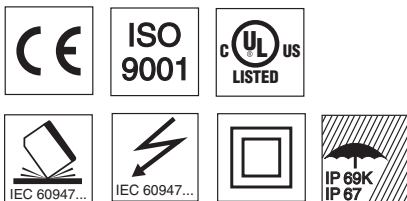

Specifications

Optical data

Typ. scanning range limit (white 90%) ¹⁾	5 ... 800mm
Scanning range ²⁾	see tables
Electrical adjustment range	0 ... 800mm
Light source	LED (modulated light)
Wavelength	660nm (visible red light)

Timing

Switching frequency	1500Hz
Response time	0.33ms
Delay before start-up	≤ 100ms

Electrical data

Operating voltage U_B	10 ... 30VDC
Residual ripple	≤ 15% of U_B
Bias current	≤ 35mA
Switching output/function	.../66 2 push-pull switching outputs ³⁾ pin 2: PNP dark switching, NPN light switching pin 4: PNP light switching, NPN dark switching
	.../44 2 PNP switching outputs pin 2: dark switching pin 4: light switching
Signal voltage high/low	≥ ($U_B - 2V$) ≤ 2V
Output current	max. 100mA
Sensitivity	adjustable with 270° potentiometer

Indicators

LED yellow	light path free
LED yellow flashing	light path free, no performance reserve

Mechanical data

Housing	metal
Optics cover	glass
Weight (plug/cable)	70g/140g
Connection type	M12 connector, 5-pin (turning), or cable: 2000mm, 5x0.25mm ²

Environmental data

Ambient temp. (operation/storage)	-40°C ... +60°C/-40°C ... +70°C
Protective circuit ⁴⁾	2, 3
VDE safety class ⁵⁾	II, all-insulated
Protection class ⁶⁾	IP 67, IP 69K ⁷⁾
LED class	1 (acc. to EN 60825-1)
Standards applied	IEC 60947-5-2

- 1) Typ. scanning range limit: max. attainable range without performance reserve
- 2) Scanning range: recommended range with performance reserve
- 3) The push-pull switching outputs must not be connected in parallel
- 4) 2=polarity reversal protection, 3=short-circuit protection for all outputs
- 5) Rating voltage 250VAC
- 6) In stop position of the turning connector (turning connector locked)
- 7) IP 69K test acc. to DIN 40050 part 9 simulated, high pressure cleaning conditions without the use of additives, acids and bases are not part of the test

Order guide

	Designation	Part No.
With M12 connector	RTR 8/44-800-S12	500 36366
With 2m cable	RTR 8/44-800	500 36367
With M12 connector	RTR 8/66-800-S12	500 36368
With 2m cable	RTR 8/66-800	500 36369

Tables

1	10	600	800
2	15	210	320
3	25	-	220

1	white 90%
2	grey 18%
3	black 6%

<input type="checkbox"/>	Scanning range [mm]
<input type="checkbox"/>	Typ. scanning range limit [mm]

Diagrams

Typ. response behaviour (white 90%)

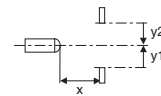
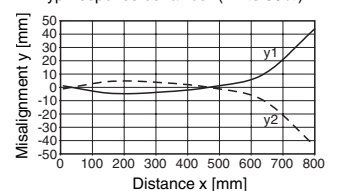

Remarks