

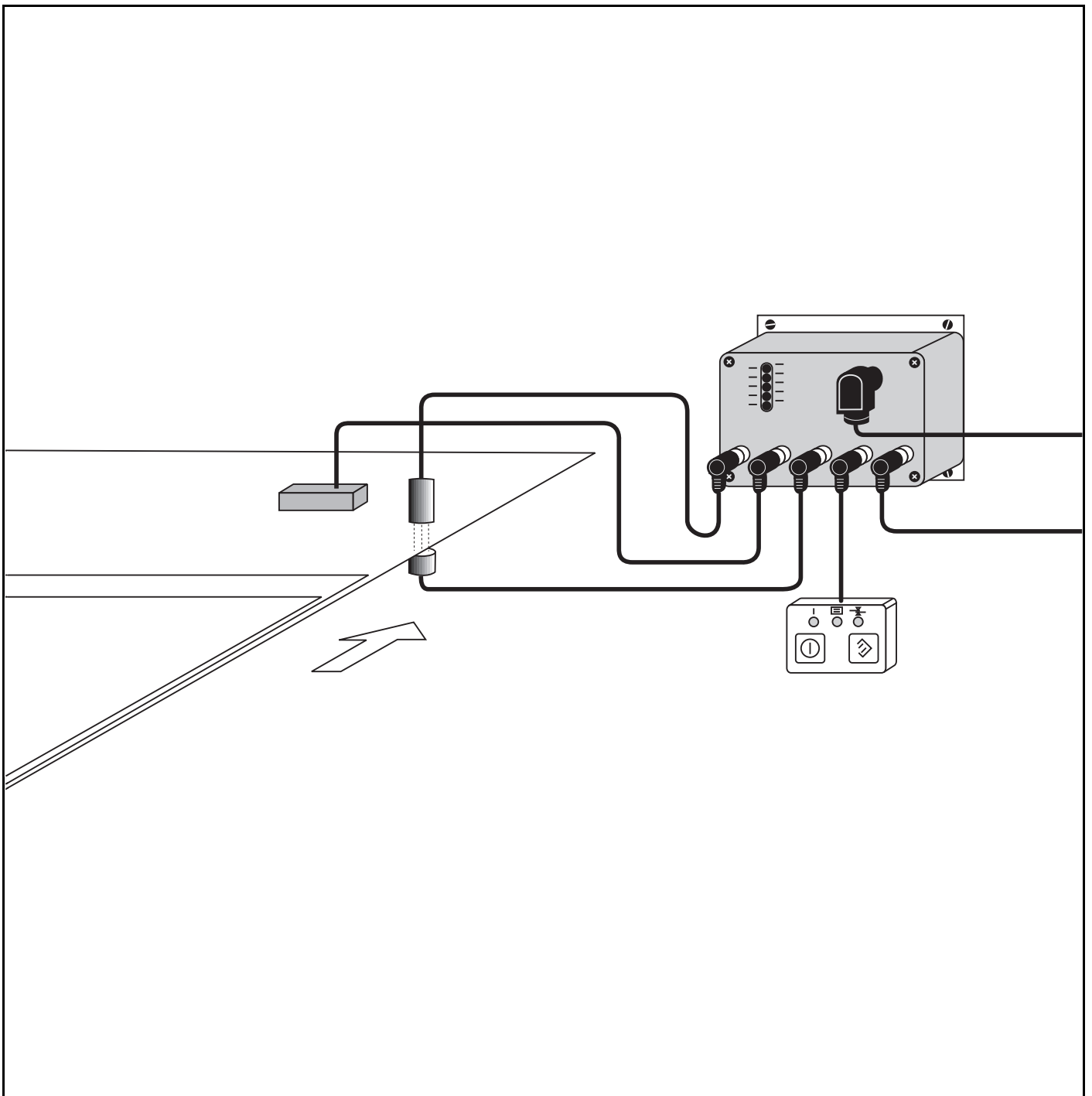

# Double Sheet Testing Unit DB 11

## Operating Manual



© All Rights reserved, in particular the rights of reproduction, distribution, and translation. Duplication or reproduction in any form (print, photocopies, microfilm or data) may only be carried out with the expressed written consent of Leuze electronic GmbH + Co.

We reserve the right to make changes for the technical improvement of the product.

## Table of Contents

|          |  |           |
|----------|--|-----------|
| <b>1</b> | <b>General Information .....</b>                             | <b>2</b>  |
| 1.1      | Explanation of Symbols.....                                  | 2         |
| 1.2      | Important Expressions and Abbreviations.....                 | 2         |
| 1.3      | Declaration of Conformity.....                               | 2         |
| <b>2</b> | <b>Safety Notices.....</b>                                   | <b>3</b>  |
| 2.1      | Safety Standard .....  | 3         |
| 2.2      | Intended Use.....  | 3         |
| 2.3      | Areas of Application .....                                   | 3         |
| 2.4      | Organisational Measures .....                                | 3         |
| <b>3</b> | <b>Description of the Device and System .....</b>            | <b>4</b>  |
| 3.1      | Set-up of the DB 11.....                                     | 4         |
| 3.2      | Performance features of the DB 11 .....                      | 4         |
| 3.3      | Function Description DB 11 .....                             | 5         |
| 3.4      | KA 905 Mode .....  | 5         |
| 3.5      | Delivery Contents / Accessories / Ordering Descriptions..... | 5         |
| <b>4</b> | <b>Installation .....</b>                                    | <b>6</b>  |
| 4.1      | Storage, Transportation .....                                | 6         |
| 4.2      | Mounting .....   | 7         |
| 4.3      | Connection .....   | 8         |
| 4.4      | Disassembling, Packing, Disposing .....                      | 9         |
| <b>5</b> | <b>Commissioning .....</b>                                   | <b>10</b> |
| 5.1      | Before switching on for the first time .....                 | 10        |
| 5.2      | Display and Control Elements.....                            | 10        |
| 5.3      | Switching on.....  | 12        |
| 5.4      | Adjustment .....   | 12        |
| <b>6</b> | <b>Sheet testing.....</b>                                    | <b>15</b> |
| 6.1      | Operating status.....  | 15        |
| 6.2      | Calibration .....  | 16        |
| 6.3      | Testing for Double Sheets / Missing Sheets .....             | 17        |
| 6.4      | Outside of Measurement Range .....                           | 18        |
| 6.5      | Testing for Second Sheet.....                                | 18        |
| <b>7</b> | <b>Software .....</b>  | <b>19</b> |
| 7.1      | Connecting RS 232 Interface .....                            | 19        |
| 7.2      | Display Measurement Values .....                             | 19        |
| 7.3      | Basic Settings .....   | 20        |
| <b>8</b> | <b>Technical Data .....</b>                                  | <b>21</b> |
| 8.1      | General Specifications .....                                 | 21        |
| 8.2      | Dimensions .....   | 22        |
| <b>9</b> | <b>Maintenance.....</b>                                      | <b>24</b> |
| 9.1      | General Maintenance Information.....                         | 24        |
| 9.2      | Repair, Maintenance .....                                    | 24        |

# 1 General Information

## 1.1 Explanation of Symbols

The symbols used in this operating manual are explained below.



### Attention

*This symbol appears in front of text which must be carefully observed. Failure to heed this information can lead to injuries to personnel or damage to the equipment.*



### Notice

*This symbol indicates text which contains important information.*

 This symbol refers you to other chapters or other literature.

 This symbol indicates operations which are to be carried out.

*Italics* Important terms and keywords which help you locate information quickly appear to the left of the text column.

## 1.2 Important Expressions and Abbreviations

*DST* Double sheet testing unit

*Registered* The sensor is entered into the DST menu and used for measurements.

## 1.3 Declaration of Conformity

**The manufacturer of the product possesses a certificated quality control system in accordance with ISO 9001.**



## 2 Safety Notices

### 2.1 Safety Standard

The DB 11 double sheet testing unit has been developed subject to the applicable safety standard IEC 947-5-2.

### 2.2 Intended Use

The DB 11 Double Sheet Testing Unit has been conceived as a monitoring device for printing machines. It tests incoming sheets of paper in clock-controlled machines. It recognizes and indicates double sheets in the sheet feeder.



#### Attention

*The protection of the machine and the device cannot be guaranteed if the device is operated in a manner not corresponding to its intended use.*

*Entering or making changes to the device, except where expressly described in this operating manual, is not authorized.*

### 2.3 Areas of Application

Double sheets of the following materials with thicknesses from 20g / m<sup>2</sup> airmail paper to 2 mm thick cardboard can be recognized reliably by the DB 11:

- Paper
- Paperboard
- Cardboard
- Plastic foil, vapour deposited, but not coated

### 2.4 Organisational Measures

|                            |   |
|----------------------------|---|
| <i>Documentation</i>       | All entries in this operating manual must be heeded, in particular those in the section "Safety Notices" and "Commissioning".<br><br>Carefully store this operating manual where it is accessible at all times. |
| <i>Safety regulations</i>  | Observe the locally applicable legal regulations.   |
| <i>Qualified personnel</i> | Mounting, commissioning and maintenance of the device may only be carried out by qualified personnel.<br><br>Electrical work must be carried out by a certified electrician.                                    |
| <i>Repair</i>              | Repairs, especially those involving opening the housing, may only be performed by the manufacturer, or by other persons authorised by the manufacturer to undertake such repairs.                               |

### 3 Description of the Device and System

#### 3.1 Set-up of the DB 11

The basic version of the double sheet testing unit DB 11 consists of the evaluation unit VDB 11/4, one transmitter DB 11 Se, one receiver DB 11 E and a connection cable for the machine control system. It can be additionally equipped with a control device DB 11 OP and a capacitive sensor DB 11 K.

*Control device DB 11 OP*

The control device DB 11 OP is particularly recommended when backfitting if the control keys of the DB 11 cannot be incorporated into the control panel of the printing machine.

*Capacitive sensor DB 11 K*

The capacitive sensor DB 11 K is required if double sheets of thick material or material with low infrared transmission should be recognized, as well as for the further processing of printed sheets (discards, perfecting).

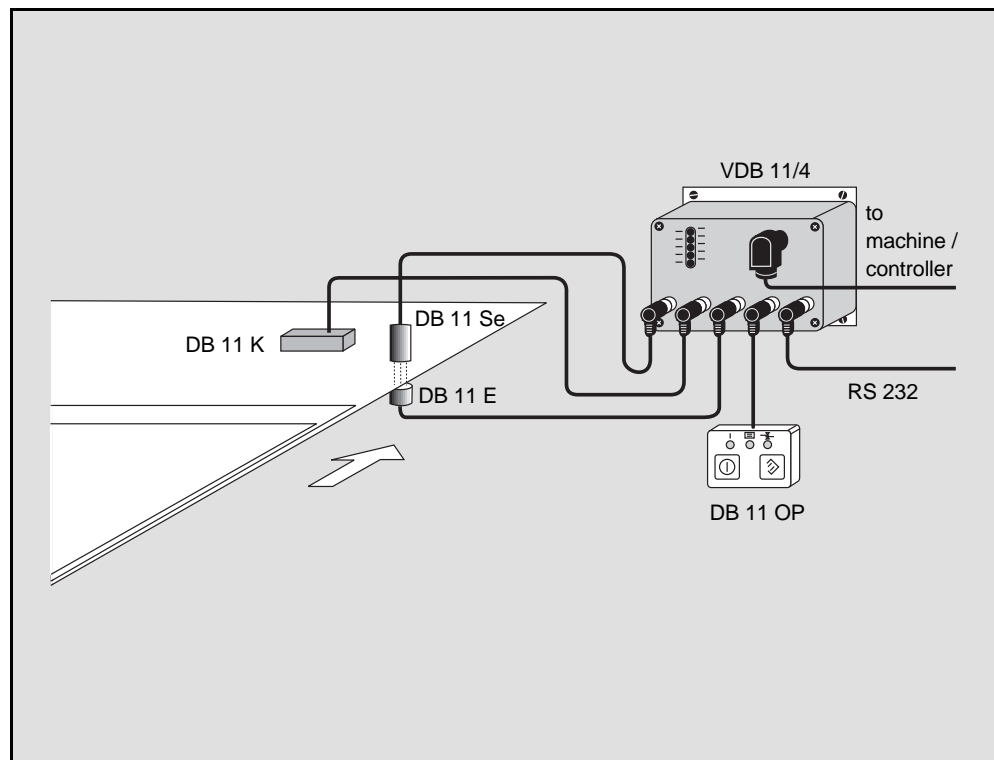

Fig. 3.1: DB 11 system set-up

#### 3.2 Performance features of the DB 11

The DB 11 is a system which detects multiple sheets of paper. It is characterised by the following features:

- A large measuring range from 20 g airmail paper to 2 mm thick, homogeneous cardboard
- Insensitive to printing and fluttering of paper
- Automatic and manual self-calibration
- Automatic readjustment during operation
- System works with optical or capacitive sensors

### 3.3 Function Description DB 11

The double sheet testing unit DB 11 is a computer-assisted system for the recognition of multiple sheets of paper or cardboard and is applicable for use in clock-controlled machines. After storing a material-specific reference value, the system can recognize multiple sheets of paper and thus prevent damage to the machine.

#### *Optical and capacitive recognition*

The infrared photoelectric sensor consists of a transmitter DB 11 Se and a receiver DB 11 E and performs two functions: It recognizes the presence of a sheet of paper by the interruption of the light beam and measures the light transmission of the material. After calibration to a reference sheet, it can be determined whether zero, one or two sheets of paper are in the light beam. The capacitive sensor will be used automatically only if the material is opaque to infrared light. However, the photoelectric sensor will still be necessary for sheet recognition.

#### *Error handling*

The reference value is always corrected to the current conditions by automatic readjustment during operation. The double sheet testing unit DB 11 gives separate error messages for double or missing sheets, so the machine control system can respond specifically to each of these errors. The testing of the sheet overlap is allowed by the possibility of an additional second inquiry at a time when two sheets should be at the measurement position and to give a warning signal should the second sheet be missing.

#### *System-specific configuration*

The perfect operation of the double sheet testing unit is checked by an integrated self-test. The system can also be checked directly by the machine operator using the display and control unit. Machine-specific adjustments and data transfer to overriding systems (control station, computer) is possible through a serial interface.

### 3.4 KA 905 Mode

Systems which are equipped for a KA 905 can be run directly with the double sheet testing unit DB 11. In this case, the DB 11 can be programmed by software in such a way that it performs like a KA 905. For further information see Chapter 7, "Software".

### 3.5 Delivery Contents / Accessories / Ordering Descriptions

500 29 135 DB 11 basic package

The basic package includes the following parts:

*Ordering number* Device description

500 25 514 VDB 11/4 evaluation unit

500 25 515 DB 11 Se transmitter

500 25 516 DB 11 E receiver

500 27 389 BK7-KB 014-2000-14 2 m connecting cable

Available accessories:

500 26 717 DB 11 OP control device

500 25 517 DB 11 K capacitive sensor

500 80 082 BK7-KB 011-2000-7 programming cable (RS 232)

500 80 284 BK7-KB 014-5000-14 5 m connecting cable

## 4 Installation

### 4.1 Storage, Transportation



#### Attention

*Use packaging which is impact resistant and moisture-proof for transport or storage. Optimal protection is achieved when using the original packaging. Make sure that the ambient conditions are within the allowed limits as described in the technical specifications.*

#### Unpacking

- Check the packaging for any damage. If damage is found, notify the post office or shipping agent as well as the supplier.
- Verify the following delivery contents according to your order and the delivery papers:
  - delivered quantity
  - device type and model as indicated on the name-plate
  - accessories
  - operating manual(s)
- Keep the original packaging in case the device should be stored or transported at some future time.

Please contact your supplier or your Leuze distributor to answer any questions (see the back of this operating manual).

- Observe the locally applicable regulations when disposing of the packaging materials.

#### Cleaning

- Use a soft cloth to clean the transmitter and receiver of the optical sensor before mounting. Remove all packaging remains such as cardboard fibres or styropor balls.



## 4.2 Mounting

The components of the DB 11 should be mounted in the following order:

- Sensors, optical und capacitive (if present)
- Evaluation unit
- Display and control unit

As long as the sensors are aligned according to the following instructions, the fitting position of all components is arbitrary. The space requirements of the individual components can be found in the dimensioned drawings in Chapter 8.

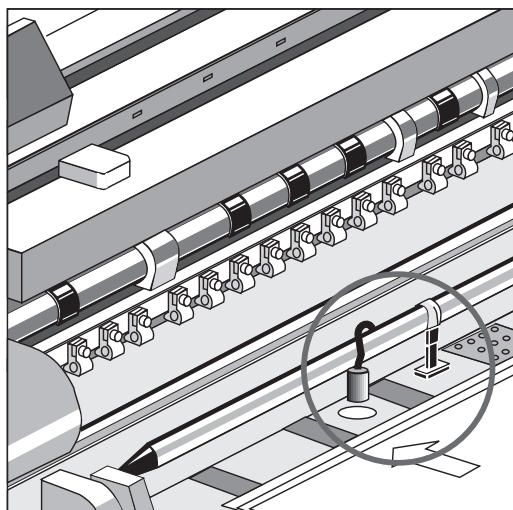

Fig. 4.1: Example for the sensor arrangement



### Notice

*The transmitter and receiver must be mounted on the feeder platform at a position where a single sheet is present for at least 2 ms during normal operation.*

Optical sensors

- ➔ Mount the transmitter and the receiver centered 12 mm  $\pm$ 0.5 mm apart. The receiver must be mounted flush in the feeder platform. The transmitter must be attached in a way which allows a subsequent readjustment of the transmitter - receiver distance (see Fig. 4.2 and Chapter 5.3, "Adjusting").

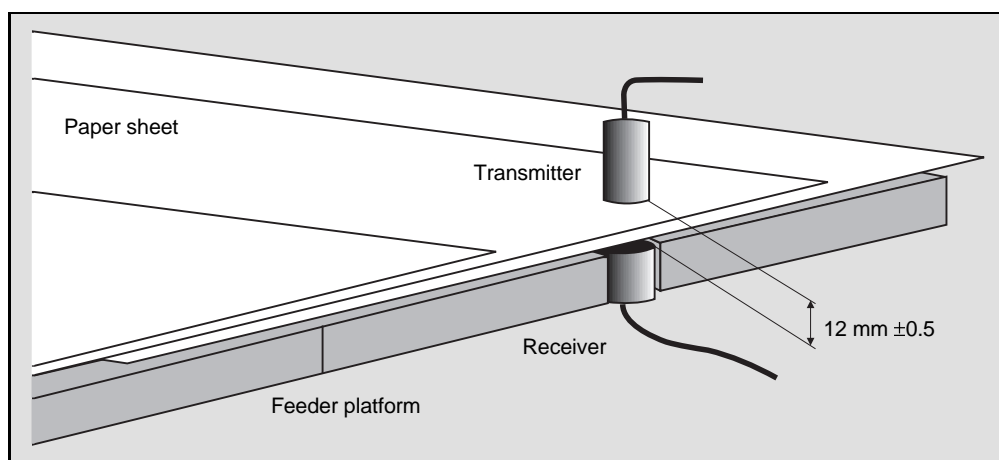

Fig. 4.2: Mounting the optical sensor



### Notice

*In order to measure, the capacitive sensor requires an electrically conductive grounding plate for the opposite pole which is at least as the sensor large as itself. Usually the (metallic) feeder platform serves this function.*

#### Capacitive sensor

- ➔ Mount the capacitive sensor parallel to and  $8\text{ mm} \pm 0.5\text{ mm}$  from the feeder platform / grounding plate. It is usually not necessary to readjust the sensor - grounding plate distance afterwards. Fix a grounding plate in a non-metallic feeder platform, taking care that the sheet movement is not disturbed. (See Fig. 4.3)
- ➔ Connect the capacitive sensor and grounding plate with a potential equalisation cable. This is absolutely necessary for a correct measurement.

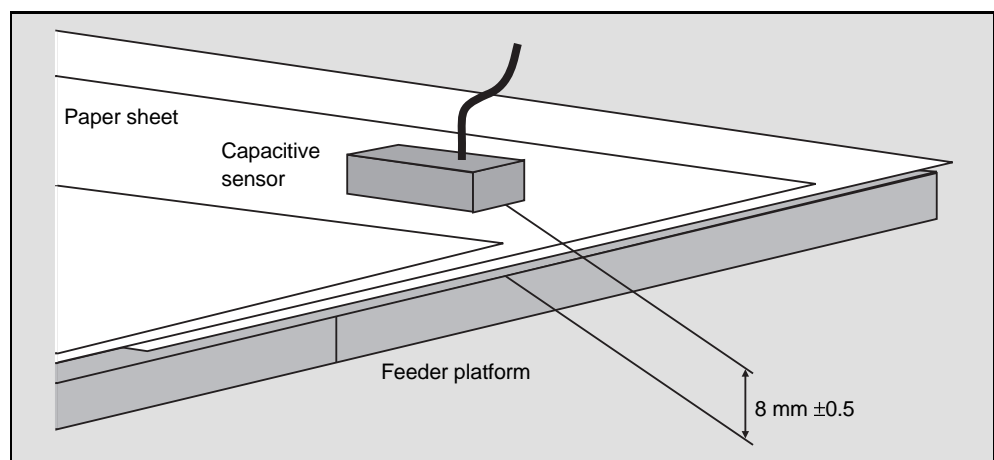

Fig. 4.3: Mounting the capacitive sensor

#### Evaluation unit

- ➔ Use the four M 4 screws to mount the evaluation unit close to the sensors, so that the sensor cables can be connected directly to the unit.

#### Display and control unit

- ➔ Use the two M 4 screws to mount the display and control unit in a position where you can hold a reference sheet in the measurement area (optical / capacitive sensor) with your free hand while operating the display and control unit. Additionally, it must be possible to connect the display and control unit to the evaluation unit with the cable.

## 4.3 Connection

- ➔ Connect the individual components to the evaluation unit at the following sockets:

- Optical sensor, transmitter to DB 11 Se
- Optical sensor, receiver to DB 11 E
- Capacitive sensor to DB 11 K
- Display and control unit to DB 11 OP
- Machine control system to the multicore socket, upper right

The following table describes the pin assignments, in case you do not use the pre-fabricated cable to connect the machine control system:

| Pin assignments for the machine control system |        |  |
|--|--------|--|
| Pin  | Color  | Function   |
| <b>Current supply</b>                          |        |  |
| A  | r      | Distribution voltage +18 ... 30 V DC                         |
| C  | blu    | Distribution voltage 0 V DC (GND)                            |
| <b>Inputs</b>                                  |        |  |
| E  | pi     | Single sheet test (inquiry signal in step with machine)      |
| G  | gry    | Double sheet test (option)                                   |
| J  | yel    | Sheet feed (ON, if sheet feed is active)                     |
| L  | grn    | Calibration  |
| M  | br     | Reference potential for inputs (connect to GND)              |
| <b>Outputs</b>                                 |        |  |
| N  | w      | Photoelectric sensors interrupted (first sheet recognition)  |
| O  | vio    | Double sheet recognized                                      |
| P  | blk    | Double sheet test unit ready (calibrated and activated)      |
| R  | w-grn  | Missing sheet (option)                                       |
| S  | r-blu  | Error  |
| T  | br-grn | Missing second sheet (option) / KA905-Mode: Capac. sensor on |
| U  | gry-pi | Capac. sensor on / KA905-Mode: Test                          |



#### Notice

*You must wire the inputs E and J in order for the DBK to function correctly. An inquiry signal from the machine control system must always then be applied to input E when a single sheet is in the measurement area for at least 2 ms from the time of inquiry during normal operation. Input J is connected directly to the sheet feed control when backfitted. In a new installation it must be linked logically in the process control system. The function characteristics of input L can also be taken over by the control unit DB 11 OP.*

## 4.4 Disassembling, Packing, Disposing

### Repacking

Use packaging which is impact resistant and moisture-proof when storing for future use. Optimal protection is achieved when using the original packaging.



#### Notice

*Electrical scrap is a special waste product! Observe the locally applicable regulations regarding disposal of the product. The double sheet testing unit DB 11 does not contain any internal batteries which need to be removed before disposal.*

## 5 Commissioning

### 5.1 Before switching on for the first time

- Make yourself familiar with the operation and settings of the system before switching on for the first time!
- Before switching on, once again inspect all connections to ensure their correctness.

### 5.2 Display and Control Elements

#### 5.2.1 Evaluation Unit VDB 11/4

There is an indicator panel with 13 LED's on the front panel of the evaluation unit VDB 11/4.

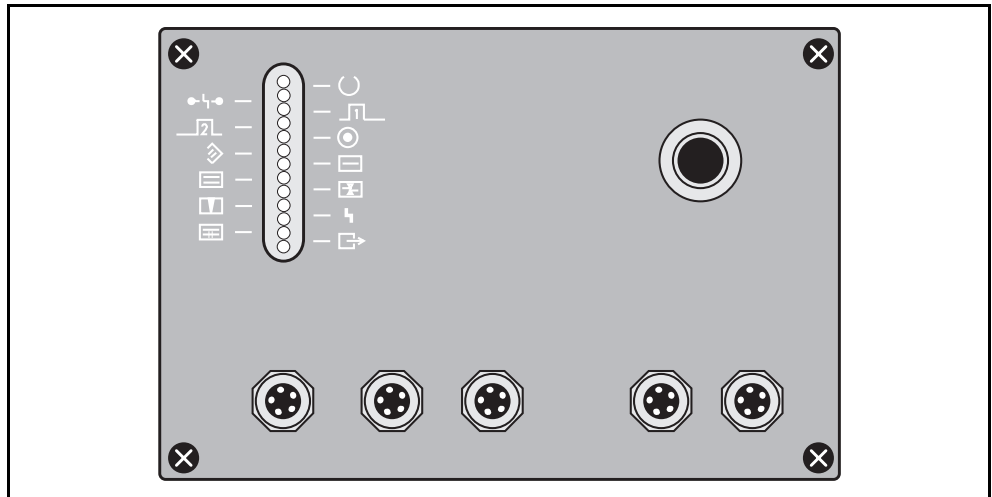

Fig. 5.1: Evaluation unit VDB 11/4

The indicator panel LED's on the VDB 11/4 can have up to three different meanings corresponding to the three modes of operation: Sheet test, Self-test and Adjustment.

#### 5.2.2 Display and Control Unit DB 11 OP

There are 3 LED's on the front panel of the display and control unit. These can also have different meanings depending on the mode of operation.

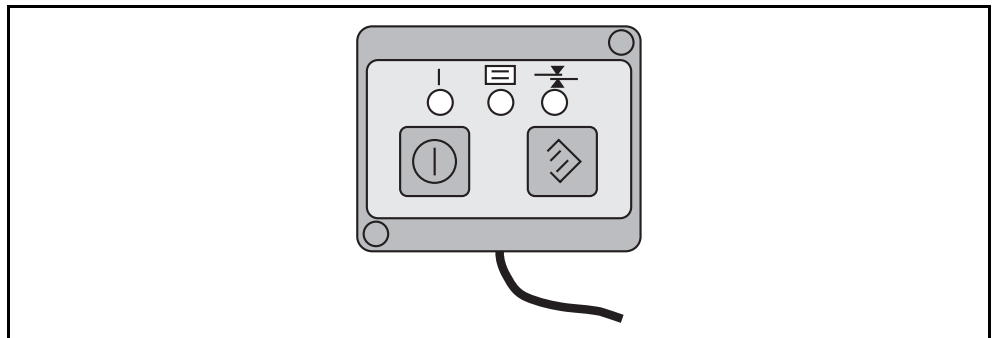















Fig. 5.2: Display and control unit DB 11 OP

### 5.2.3 LED Indicators

| LED Indicators VDB 11/4   |  |   |  |
|---|--|---|--|
| Symbol  | Sheet Test                                 | Self-test   | Adjustment mode  |
|    | DBK ready                                  |   | Signal OK (flashes for registered cap. sensor)                 |
|    | Connection error                           |   | signal not sufficient  |
|    | First inquiry                              |   |  |
|    | Second inquiry                             |   |  |
|    | Sheet feed on                              |   |  |
|    | Calibration                                | Control unit not recognized (Transm. or receiver missing) | Scale indicator for the reception signal of the optical sensor |
|    | First sheet recognized                     |   |  |
|   | Double sheet recognized                    | Transmitter or receiver not recognized                    |  |
|  | DBK activated and calibrated               |   |  |
|  | Missing sheet                              | Receiver not recognized                                   |  |
|  | Error                                      | Noise signal too large (Receiver not grounded)            |  |
|  | Second sheet missing                       | Capac. sensor registered, but not recognized              |  |
|  | Cap. sensor recognized KA905<br>Mode: Test |   |  |

See next page for the description of the operation unit LED indicators

| LED Indicators DB 11 OP |  |                                    |  |
|-------------------------|--|------------------------------------|--|
| LED                     | Sheet Test   | Self-test                          | Adjustment mode  |
| green                   | <b>flashing:</b> DBK deactivated<br><b>on:</b> DBK activated                             | <b>all 3 LED's flash:</b><br>Error | <b>flashing:</b> capacitive sensor registered<br><b>on:</b> capacitive sensor not registered |
| red                     | <b>flashing:</b> Paper outside of measurement area<br><b>on:</b> Double sheet recognized |                                    | Signal not recognized  |
| yellow                  | <b>flashing:</b> autom. calib. preselected<br><b>on:</b> DBK calibrated                  |                                    | Signal not sufficient  |

### 5.3 Switching on

The double sheet testing unit DB 11 does not have a particular switch for switching on and off. The device is switched on and off through application of the supply voltage.

*Self-test* The double sheet testing unit performs a self-test after application of the supply voltage. The upper green LED "DBK ready" turns on following the successful self-test.

### 5.4 Adjustment

The sensors are adjusted to the installation conditions in the adjustment mode.

The double sheet testing unit DB 11 needs to be adjusted when

- first commissioned,
- a sensor is exchanged, added or removed.

#### Attention



*All outputs corresponding to the indicators are turned on when in adjustment mode. Take precautionary measures in the machine control system to avoid damage caused by these signals.*

#### Notice



*Adjustment can only take place when the DBK is not calibrated and the sheet feeder is switched off. Ensure that the LED for "Sheet feed on" is off. Also make sure that there is no sheet in the measuring area.*

### 5.4.1 Starting adjustment

*Using the control unit* → Depress both keys on the control unit for longer than 5 seconds

*Without the control unit* → Send a series of 12 pulses within 12 seconds to calibration input L from the overriding control system.

Once the adjustment has started, a self-test is performed like when switching on. The VDB 11/4 recognizes automatically whether or not a capacitive sensor is connected and registers or cancels it, respectively, with the system. You can use the RS232 interface to check or change this (see Chapter 7).

### 5.4.2 Adjusting the Optical Sensor

*Signal strength adequate* The VDB 11/4 tests the signal from the optical sensor after beginning the adjustment. If the signal is recognized and lies within the acceptable signal range, the green LED on the control unit, the green LED "DBK ready" on the VDB 11/4, as well as the lower eight LED's on the VDB 11/4 will all light up (or flash).

*Signal recognized*  
*Signal strength not adequate* The illumination of the yellow LED on the control unit, together with the green LED's, indicates that the signal is strong enough, although the signal from the optical sensor was recognized. The lower eight LED's of the VDB 11/4 now serve as a scale indicator for the reception strength.

→ Loosen the fastening and shift the transmitter until all eight of the lower LED's on the VDB 11/4 light up and the yellow LED on the hand control unit turns off. Fix the transmitter in this position.

*Signal not recognized* If, instead of the green LED's, the red LED on the control unit is on, and the red LED "connection error" on the VDB 11/4 is also on, then the signal from the optical sensor was not recognized.

→ Inspect the connection cables from the transmitter and the receiver.

→ Loosen the fastening of the transmitter and check whether shifting it causes the signal to be recognized. If this is the case, shift the transmitter until the lower eight LED's on the VDB 11/4 illuminate and the yellow LED on the hand control unit turns off. Fix the transmitter in this position.

### 5.4.3 Adjusting the capacitive sensor

After the adjustment of the optical sensor, the lower eight LED's on the VDB 11/4 indicator are illuminated.

The flashing of one of these LED's together with both green LED's on the VDB 11/4 and the control unit indicates that the capacitive sensor is connected and registered.

*Acceptable signal* The signal strength of the capacitive sensor is represented by the flashing LED on the scale indicator. If one of the central LED's is flashing, then the signal is in the acceptable range and the adjustment can be terminated.

*Unacceptable signal* If one of the outer two LED's of the scale indicator are flashing, then the signal does not lie within the acceptable range.

→ Loosen the fastening and shift the capacitive sensor until one of the central LED's flashes. Fix the capacitive sensor in this position.

### 5.4.4 Terminating Adjustment

The adjustment must last at least ten seconds.

*Using the control unit* → Press any key of the control unit.

*Without the control unit* → Set the calibration input L to 0 VDC.

The adjustment is now completed and the VDB 11/4 recognizes the parameters of the connected sensors. Before initiating sheet testing operation it is now necessary to calibrate to the paper type so that the VDB 11/4 can reliably recognize double sheets.



## 6 Sheet testing

### 6.1 Operating status

In order to recover operation after an error alarm it is necessary to

- remove the double sheet
- deactivate the DBK 11 and activate it again

#### 6.1.1 Using the Control Unit

The DBK has two states of operation: "activated" and "deactivated", which can only be selected using the left key on the control unit DB 11 OP. They allow manual calibration using the control unit DB 11 OP and the deactivation of the DBK during a waste paper run.

*Activated* During the "activated" state of operation

- the green LED's on the control unit and the LED "DBK activated and calibrated" on the VDB 11/4 are illuminated
- the DBK is calibrated and ready for sheet testing, i.e. upon receiving the inquiry signal on input E, the DBK tests whether a missing sheet, a single sheet or a double sheet is in the measurement area and switches on the corresponding outputs
- it is not possible to calibrate manually

*Deactivated* During the "deactivated" state of operation

- the green LED on the control unit flashes and the LED "DBK activated and calibrated" on the VDB 11/4 is off
- the DBK outputs are locked
- it is possible to calibrate manually

#### 6.1.2 Without the Control Unit

Without the control unit, the states of operation "activated" and "deactivated" must be selected using the input "sheet feed on".

*Activated* During the "activated" state of operation

- the LED "sheet feed on" on the VDB 11/4 is illuminated
- +24 VDC are on input J
- the DBK is calibrated and ready for sheet testing, i.e. upon receiving the inquiry signal on input E, the DBK tests whether a missing sheet, a single sheet or a double sheet is in the measurement area and switches on the corresponding outputs
- it is not possible to calibrate manually

*Deactivated* During the "deactivated" state of operation

- the LED "Sheet feed on" on the VDB 11/4 is off
- 0 VDC is applied to input J
- the DBK outputs are locked
- it is possible to calibrate manually

## 6.2 Calibration

After an adjustment or if the sheet material is changed, it is necessary to calibrate the DBK. This can be done in two ways: manually or automatically.

*Manual calibration* During manual calibration, a reference sheet is held in the measurement area and the DBK is calibrated to this sheet. Manual calibration is only allowed when the sheet feeder is off.

*Automatic calibration* During automatic calibration, the DBK is calibrated to the first sheet which is in the measurement area at the time of inquiry. Automatic calibration is only allowed when the sheet feeder is on.

### 6.2.1 Manual Calibration



#### Notice

*Manual calibration can only take place when the sheet feeder is off. Make sure that the LED "sheet feed on" on the VDB 11/4 is off before starting the calibration. Additionally, manual calibration must be registered in the menu (see Chapter 7).*

→ Hold a reference sheet in the measurement area

*Using the control unit  
DB 11 OP*

→ Depress the calibration key (right) for longer than two seconds: the yellow LED over the calibration key will flash.

→ Release the calibration key. The reference value is stored and the yellow LED stays on.

*Without the control unit  
DB 11 OP*

→ Apply +24 V DC to the input L "calibration": the calibration follows and the reference value is stored.

Following the successful calibration, the LED "DBK active and calibrated" on the VDB 11/4 is illuminated and the operating voltage is applied to the output P "ready".

### 6.2.2 Automatic Calibration



#### Notice

*Automatic calibration can only take place when the sheet feeder is on. Make sure that the LED "Sheet feed on" on the VDB 11/4 is illuminated before starting the calibration. Additionally, automatic calibration must be registered in the menu (see Chapter 7).*

→ Depress the calibration key (right) for longer than two seconds: the yellow LED over the calibration key will flash; or apply +24 V DC to input L "calibration" of the VDB 11/4.

The unit will now be calibrated to the first sheet which is in the measurement area when the inquiry signal is applied to input E. The calibration procedure takes 6 ms. Following the successful calibration, the LED "DBK active and calibrated" on the VDB 11/4 is illuminated and the operating voltage is applied to the output P "ready".

- Advantages* Automatic calibration is possible both while the machine is running or when it is started.
- Disadvantages* The printing machine might need to be run more slowly because the sheet must be in the measurement area for 6ms during calibration, as compared to the 2ms required for normal sheet testing. If the sheet measured for calibration is a double sheet, then the unit will be calibrated to the wrong value.

### 6.2.3 Calibration Errors

It can happen that a calibration is not possible because the reference material is too thin, too thick or not suitable. In this case the red LED on the control unit will flash and the output S "error" will be switched on.

*Thick paper* If the paper is too thick, the output P "double sheet" will additionally be switched on.

→ Check whether the capacitive sensor is registered.

*Thin paper* If the paper is too thin, the output R "missing sheet" will additionally be switched on.

→ Check whether the optical sensor is registered.

→ Clear the error alarm by depressing the left key on the control unit or by setting input L "calibration" to 0 VDC.

## 6.3 Testing for Double Sheets / Missing Sheets

The sheet testing can begin if the DBK is calibrated and activated.

The DBK tests whether one or two sheets are in the measurement area when the inquiry signal is applied to input E. The number of sheets in the measurement area must remain constant for the 2 ms required for the measurement.

The DBK does not give a signal when a single sheet is detected during normal operation, as this corresponds to the expected situation. For visual confirmation, the yellow LED on the control unit and the LED "calibration" on the VDB 11/4 flash briefly.

*Missing sheet* The output R "missing sheet" is set if no sheet is detected during normal operation. The output signal is cleared following the next inquiry which shows a correct sheet. Alternatively, you can apply 0 VDC to the input J "sheet feed on" for a short time in order to clear output R.

A missing sheet will not block the DBK. Sheet testing operation can continue even without clearing output R.

*Double sheet* If two sheets are detected, then output O "double sheet" is activated and the red LED on the control unit illuminates. The maximum amount of time between inquiry and activation of output O is 2 ms, i.e. a double sheet is recognized within 2 ms of the inquiry signal. The process control system must be able to stop the process taking this switching-off time into consideration.

After a double sheet has been recognized and the process stopped:

→ Remove both sheets from the measurement area so that the light beam is not blocked.

→ Set input J "sheet feed on" shortly to 0 VDC in order to clear output O.

The DBK stays blocked, i.e. output O stays activated, until the double sheet is removed (light beam uninterrupted) and input J "sheet feed on" is set shortly to 0 VDC.

## 6.4 Outside of Measurement Range

If the measured value is outside of the measurement range when requested, then the "error" output is activated. The red LED on the control unit will also flash.

Additionally, if the sheet is too thick (range exceeded) output O will be activated, and if the sheet is too thin (below range) output R will be activated.

## 6.5 Testing for Second Sheet

*Sheet overlap* Sheet overlap can be tested by sending a second inquiry signal to input G at a time when two sheets should be passing the measurement area. This second inquiry can be activated and deactivated using the RS232 interface.

If the DBK recognizes only one or no sheet at the time of the second inquiry, the output T "second sheet missing" will be activated.

The output is cleared again the next time a correct second sheet is found. Alternatively, you can set input J "sheet feed on" shortly to 0 VDC in order to clear output T.

A missing second sheet will not block the DBK. Sheet testing operation can continue even without clearing output T.

## 7 Software

### 7.1 Connecting RS 232 Interface

The VDB 11/4 is equipped with a serial interface in the right socket on the front side. You can connect a PC to this interface in order to adjust basic settings.

- ➔ Connect the VDB 11/4 using the 9 channel subD socket of a serial PC interface with standard configuration. Use the programming cable KB011-2000-7
  - Start a commercially available terminal emulation programme with the following settings:
  - 8 data bits
  - no parity
  - 1 stopbit
  - no handshake
  - 9600 baud

The terminal emulation programme should not buffer the keyboard input. VT 100 control characters are used.

### 7.2 Display Measurement Values

While the DBK is activated and calibrated, it will output the transmission level and corresponding reception signal for every inquiry through the serial interface.

These values can be useful for servicing purposes.

*Transmission level* The DBK uses the optical sensor for transmission level 1 to 11. The capacitive sensor is required for transmission level 12. In the case that transmission level 12 is required and the capacitive sensor is not registered in the menu, then the DBK cannot be calibrated. It will indicate that the range has been exceeded after an attempt to calibrate.

### 7.3 Basic Settings

You can use the basic settings to influence the operating performance of the DBK. You can determine which type of calibration is possible, which operational state the DBK takes once the distribution voltage is applied, which sensors are used for the measurements, whether or not a second inquiry for a second sheet occurs and whether or not the DBK should perform like a KA905.

→ Set input J "sheet feed on" to 0 VDC to deactivate the DBK.

→ Type the character string dsf and press "Return". The following menu opens:

|                |   |                                     |
|----------------|---|-------------------------------------|
| <i>Example</i> | 1 | measure reference                   |
|                | 2 | output measured values continuously |
|                | 3 | ( x ) manual calibration allowed    |
|                | 4 | ( x ) automatic calibration allowed |
|                | 5 | ( ) automatic calibration at start  |
|                | 6 | ( ) stored status at start          |
|                | 7 | ( x ) optical sensor registered     |
|                | 8 | ( x ) capacitive sensor registered  |
|                | 9 | ( ) second inquiry                  |
|                | M | ( ) KA905 mode                      |
|                | 0 | quit                                |

→ Type the number of the menu list you wish to change.

The display is updated, but the settings are only accepted and stored once 0 (quit) is selected.

*Measure reference* The value is measured and displayed.

*Output measured values continuously* The values are measured continuously and outputted to the RS 232 interface.

*Manual calibration allowed* It is possible to calibrate manually.

*Automatic calibration allowed* See Chapter 6.2

*Automatic calibration at start* The next time the DBK is switched on, it will calibrate to the first sheet which is in the measurement area at the time of inquiry and it is not necessary to set the "calibration" signal.

*Stored status at start* The DBK continues to use the previously determined reference value when it is switched on.

*Second inquiry* See Chapter 6.5, "Testing for Second Sheet"

*KA905 mode* The inputs and outputs of the DBK 11 perform like a KA905

## 8 Technical Data

### 8.1 General Specifications

Manufacturer: Leuze electronic GmbH + Co.,  
In der Braike 1, D-73277 Owen / Teck

Model: DB 11, Double Sheet Testing Unit

#### General data

Housing VDB 11/4 Aluminium  
Dimensions VDB 11/4  
without plug 48 x 145 x 165 mm (H x W x D)

Weight approx. 2000 g  
Protection class IP 54 evaluation unit  
IP 65 sensor technology

#### Power supply

Operating voltage 18 ... 30 V DC  
Current consumption < 300 mA at 24 V DC

#### Sensors

Optical sensor Infrared, wavelength 880 nm  
Capacitive sensor Nominal capacitance 5pF

#### Control and Display Elements

VDB 11/4 Display 13 LED's  
Control unit DB 11 OP 3 LED's, 2 control keys

#### Interfaces

RS232 for basic settings and displaying  
measurement values

#### Environmental conditions

Operating temperature range 0 ... + 50°C  
Storage temperature range - 30 ... + 70°C  
Air humidity max. 80 % rel. humidity, non-condensing  
Vibration tested according to IEC 947-5-2  
Shock tested according to IEC 947-5-2  
EMV tested according to IEC 947-5-2







## 9 Maintenance

### 9.1 General Maintenance Information

The double sheet testing unit DB 11 does not normally require any maintenance from the operator.

*Cleaning* → Clean the soiled transmitter and receiver with a soft cloth.



#### **Attention**

*Do not use an aggressive cleaning material such as thinner or acetone to clean the device.*

### 9.2 Repair, Maintenance

The devices can only be repaired by the manufacturer.

☞ Contact your Leuze distribution oder service organisation for repairs. The addresses are listed on the reverse of this description.